

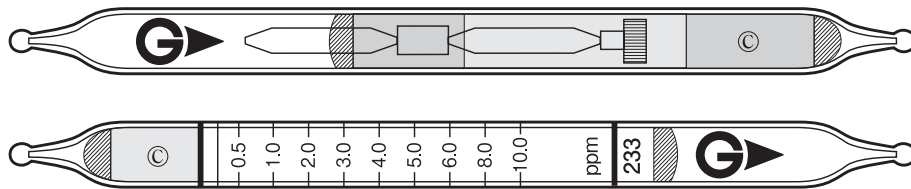

## NEW tubes

### Chloropicrin No.233



Scale range	(0.1)-10ppm
Measuring range	0.045-22ppm
Colour change	White→Yellow
Shelf life	1 year

### I,2-Dichloroethane No.232

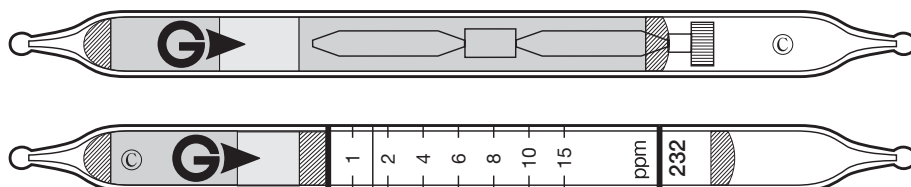

Scale range	1-15ppm
Measuring range	1-39ppm
Colour change	White→Pale purple
Shelf life	1 year (Refrigerated storage)

# PREPARATION

## Inspecting the pump model GV-100 before measurement (air leak check)

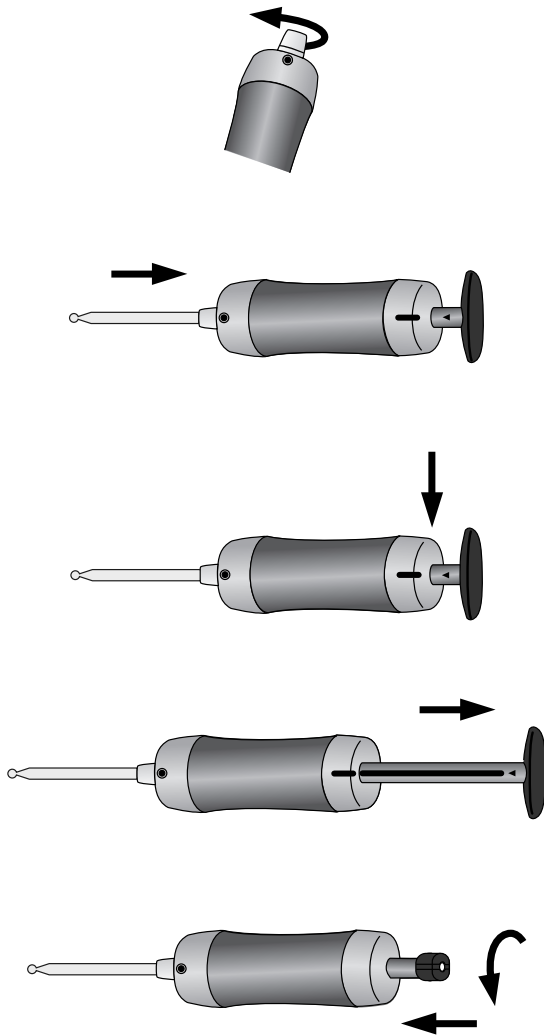

(1) Confirm that the inlet clamping nut is firmly tightened.

(2) After confirming that the pump handle is fully in (therefore, the guide line on the pump shaft is not seen), insert a fresh unbroken detector tube into the rubber inlet of the pump.

(3) Align the guide mark (red line) on the back plate and the guide mark (▲100) on the handle.

(4) Pull out the handle fully along the red guide line on the pump shaft to the lock position, and wait 1 minute.

(5) Unlock the handle by turning it more than 1/4 turns and guide it back gradually.

(6) Confirm the handle returns to the initial position and the guide line on the pump shaft is not seen.

### △ NOTE

When the handle is unlocked, be sure to guide it back gradually by applying a little resistance. Otherwise, the handle will spring back due to the vacuum in the pump cylinder and possibly damage internal parts.

### △ NOTE

The above air leak check feature in accordance with EN1231,4.2.

### Detector Tube

#### ■ Single tube (Example: No. 1HH Carbon Monoxide)

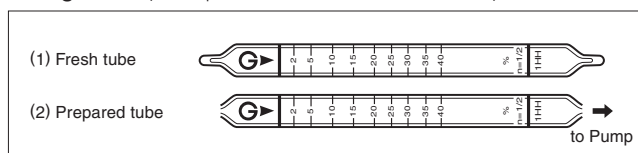

#### ■ Twin tube (Example: No. 163L Ethylene Oxide)

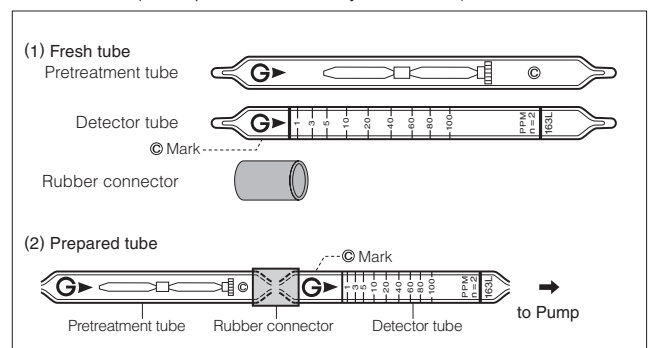

# OPERATION

## Simple and accurate measurements with the Gastec standard detector tube system

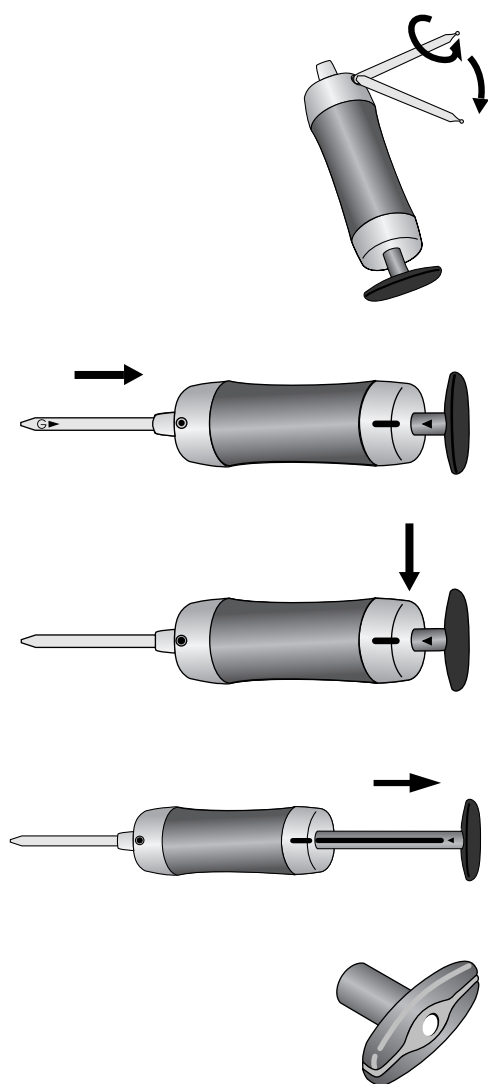

- Insert the detector tube end straight into the tube tip breaker of the Pump.
- Rotate the detector tube so that the diamond cutter of the tube tip breaker scratches the surface of the tube end.
- Hold the detector tube firmly near the tube tip breaker and bend the tube toward you to break the tube tip.
- Confirm the pump handle is fully pushed in (therefore, the guide line on the pump shaft is not seen). Then insert the detector tube into the rubber inlet of the Pump with the arrow (▶) on the tube pointing toward the pump.
- Align the guide mark (red line) on the back plate and the guide mark (▲100 or ▲50 depending on the detector tube) on the handle.
- Direct the tube end to the point of measurement and pull out the handle fully (for 100mL sampling) or halfway (for 50mL sampling) along the guide line to the lock position.
- Wait until the sampling time has elapsed. The completion of the sampling of 100mL or 50mL can be confirmed by the flow finish indicator on the handle.

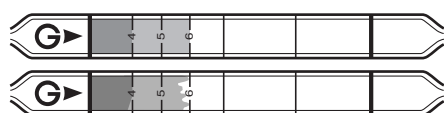
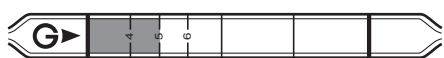

### How to read the detector tube

- The end of the colour change layer flat: Read the value at the end of the layer. In this example, the reading should be 5%.
- The end of the colour change layer slanted: Read the value in the middle of the slant. In this exaggerated example, the reading should be 5%.
- The demarcation of the colour change layer pale: Read the value in the middle between the dark layer end and the pale layer end. In this exaggerated example, the reading should be 5%.

### △ NOTE

Read instructions for your Gastec detector tube and model GV-100S carefully.

Gas or Vapour to be Measured Chemical Formula	Tube No. & Name		Measuring Range (ppm)	No. of Pump Strokes	Colour Change		Shelf Life (year)	Note	TLV-TWA, C (ACGIH) (ppm)
					Original	Stain			
Acetaldehyde CH <sub>3</sub> CHO	92	Acetaldehyde	300-750	1	Yellow	Red	2*		C 25
			10-300	②					
	5-10	4							
	92M	Acetaldehyde	5-100	①	Yellow	Red	2*		
	92L	Acetaldehyde	1-20	1	Yellow	Brown	2*	T	
Acetic acid CH <sub>3</sub> CO <sub>2</sub> H	81	Acetic acid	50-100	1/2	Pink	Yellow	3	H	10
			2-50	①					
			1-2	2					
	81L	Acetic acid	10-25.0	1/2	Pink	Pale yellow	2*	T	
			0.25-10	①					
			0.125-0.25	2					
Acetic anhydride (CH <sub>3</sub> CO) <sub>2</sub> O	81	Acetic acid	0.6-15	1	Pink	Yellow	3	H	1
	81L	Acetic acid	0.15-6	1	Pink	Pale yellow	2*	T	
Acetone CH <sub>3</sub> COCH <sub>3</sub>	151	Acetone	0.8-2.0%	1	Orange	Dark green	3	T	500
			0.05-0.8%	②					
	151L	Acetone	4000-12000	1	Yellow	Red	2*	T	
			50-4000	②					
Acetone cyanohydrin (CH <sub>3</sub> ) <sub>2</sub> C(OH)(CN)	12L	Hydrogen cyanide	2.5-60	1	Yellow	Pink	2	T	C5mg/m <sup>3</sup>
Acetonitrile CH <sub>3</sub> CN	52	Nitro compounds (Pyrotec tube)	3-180	1	White	Yellowish orange	3	P	20
Acetylene HC≡CH	171	Acetylene	2.0-4.0%	1/2	White	Brown	3	T	
			0.1-2.0%	①					
			0.05-0.1%	2					
	103	Hydrocarbons (Lower class)	1.8-3.6%	1/2	Yellowish brown	Greenish brown	2	++	
			0.15-1.8%	1					
			0.075-0.15%	2					
	172	Ethylene	32.5-1040	1	Pale yellow	Blue	3	T	
Acetylene dichloride	See 1,2-Dichloroethylene								
Acid gases	80	Acid gases	40-80	1	Pale bluish purple	Yellow	2		
			2-40	②					
			1-2	4					
Acrolein CH <sub>2</sub> :CHCHO	93	Acrolein	10-800	②	Yellow	Red	2*	T	C 0.1
			3.3-10	4					
Acrylic acid CH <sub>2</sub> :CHCO <sub>2</sub> H	81	Acetic acid	2-50	1	Pink	Yellow	3	H	2
	81L	Acetic acid	0.45-18	1	Pink	Pale yellow	2*	T	
Acrylonitrile CH <sub>2</sub> :CHCN	191	Acrylonitrile	120-360	1	Yellow	Red	3	+T	2
			5-120	②					
			2-5	4					
	191L	Acrylonitrile	6-18	1	Yellow	Pink	3	+	
			0.2-6	②					
			0.1-0.2	4					
	102L	Hexane	600-14400	1	Orange	Dark green	3		
Aliphatic hydrocarbons	140	Aliphatic hydrocarbons	1000-3000	1/2	Yellow	Dark brown	2	T	Alkane (C <sub>1</sub> -C <sub>4</sub> ) 1000
			20-1000	①					
			6-20	2					
Allyl amine CH <sub>2</sub> :CHCH <sub>2</sub> NH <sub>2</sub>	180	Amines	8.5-170	1	Pink	Yellow	3	T	
	180L	Amines	0.4-8	1	Pink	Pale orange	2	T	
Allyl isothiocyanate CH <sub>2</sub> :CHCH <sub>2</sub> NCS	149	Methyl methacrylate	5-200	2	Yellow	Pale blue	2	T	

T: Temp Correction H: Humidity Correction +: Twin Tubes ++: Nine Tubes \* Refrigerated Storage Mesh: Correction Factor/Chart

P: Use Pyrotec pyrolyzer No. 840 and GASTEC gas sampling pump.

See page 36 for additional symbols and definitions.

Gas or Vapour to be Measured Chemical Formula	Tube No. & Name		Measuring Range (ppm)	No. of Pump Strokes	Colour Change		Shelf Life (year)	Note	TLV-TWA, C (ACGIH) (ppm)
					Original	Stain			
Allyl chloride CH <sub>2</sub> :CHCH <sub>2</sub> Cl	101L	Gasoline (Petrol)	0.1-3.4%	1/2	Orange	Dark green	3		1
	131L	Vinyl chloride	3.2-48	2	Yellow	Reddish brown	2*	+T	
Amines CH <sub>3</sub> NH <sub>2</sub> calibration	180	Amines	5-100	1	Pink	Yellow to Brown	3	T	
	180L	Amines	0.5-10	1	Pink	Yellow to Pale orange or Grayish purple	2	T	
2-Aminoethanol	See Ethanolamine								
Ammonia NH <sub>3</sub>	3H	Ammonia	16-32% 1-16% 0.2-1%	1/2 ① 2-5	Purple	Yellow	3		25
	3HM	Ammonia	1.6-3.52% 0.05-1.6%	1/2 ①	Pink	Yellow	3		
	3M	Ammonia	500-1000 50-500 10-50	1/2 ① 2-5	Purple	Yellow	3		
	3La	Ammonia	100-200 5-100 2.5-5	1/2 ① 2	Purple	Yellow	3	T	
	3L	Ammonia	30-78 1-30 0.5-1	1/2 ① 2	Pink	Yellow	3	T	
	180	Amines	1.5-30	1	Pink	Yellow	3	T	
Amyl acetate CH <sub>3</sub> CO <sub>2</sub> (CH <sub>2</sub> ) <sub>4</sub> CH <sub>3</sub>	147	Amyl acetate	10-200	2	Yellow	Pale blue	2	T	50
Aniline C <sub>6</sub> H <sub>5</sub> NH <sub>2</sub>	181	Aniline	30-60 2.5-30 1.25-2.5	2 ③ 5	Pale yellow	Pale green	3		2
Arsine AsH <sub>3</sub>	19LA	Arsine	2.4-10 1.5-2.4 0.1-1.5 0.04-0.1	1 3 ⑤ 10	Yellow	Red	2		0.005
Aromatic hydrocarbons	120	Aromatic hydrocarbons	100-200 2-100 0.4-2	1/2 ① 2-5	White	Brown	3		
Benzaldehyde C <sub>6</sub> H <sub>5</sub> CHO	91L	Formaldehyde	4-92	1	Yellow	Reddish brown	3*	T	
Benzene C <sub>6</sub> H <sub>6</sub>	121S	Benzene	120-312 5-120 2-5	1 ② 4	White	Dark green	3	+	0.5
	121	Benzene	60-120 5-60 2.5-5	1 ② 4	White	Dark green	3		
	121SL	Benzene	20-100 1-20	1 ⑤	White	Dark green	3	+	
	121L	Benzene	10-65 0.1-10	1 ⑤	White	Dark green	3	+	
	121SP	Benzene	20-66 0.2-20	1 ③	White	Brown	2	+	
	171	Acetylene	0.03-0.6%	4	White	Brown	3	T	
Benzyl bromide C <sub>6</sub> H <sub>5</sub> CH <sub>2</sub> Br	136L	Methyl bromide	10-100	1	White	Yellow	2	+	

T: Temp Correction H: Humidity Correction +: Twin Tubes ++: Nine Tubes \* Refrigerated Storage Mesh: Correction Factor/Chart  
P: Use Pyrotec pyrolyzer No. 840 and GASTEC gas sampling pump.  
See page 36 for additional symbols and definitions.

Gas or Vapour to be Measured Chemical Formula	Tube No. & Name		Measuring Range (ppm)	No. of Pump Strokes	Colour Change		Shelf Life (year)	Note	TLV-TWA, C (ACGIH) (ppm)
					Original	Stain			
Benzyl chloride C <sub>6</sub> H <sub>5</sub> CH <sub>2</sub> Cl	132L	Trichloroethylene	1.6-20	2	Yellow	Purple	2*	T	1
Boron trichloride BCl <sub>3</sub>	12L	Hydrogen cyanide	2.25-54	1	Yellow	Pink	2	T	
Bromine Br <sub>2</sub>	8La	Chlorine	0.05-0.8	4	White	Pale pink	3		0.1
Bromochloromethane	See Chlorobromomethane								
Bromoform CHBr <sub>3</sub>	136L	Methyl bromide	1-50	1	White	Yellow	2	+	0.5
1,3-Butadiene CH <sub>2</sub> :CHCH:CH <sub>2</sub>	174	1,3-Butadiene	50-800	1	Pale yellow	White	3	T	2
	174L	1,3-Butadiene	5-100 2.5-5	④ 8	Pale yellow	White	3		
	174LL	1,3-Butadiene	0.5-5	1	Pink	Pale yellow	3*	+	
Butane C <sub>4</sub> H <sub>10</sub>	104	Butane	25-1400	1	Orange	Dark green	3		
	103	Hydrocarbons (Lower class)	0.84-1.68%	1/2	Yellowish brown	Greenish brown	2	++	
			0.07-0.84%	1					
0.035-0.07%	2								
1-Butanol CH <sub>3</sub> CH <sub>2</sub> CH <sub>2</sub> CH <sub>2</sub> OH	114	1-Butanol	10-150	3	Yellow	Pale blue	3	T	20
2-Butanol CH <sub>3</sub> CH <sub>2</sub> CH(OH)CH <sub>3</sub>	115	2-Butanol	5-150	3	Yellow	Pale blue	3	T	100
2-Butanone	See Methyl ethyl ketone (MEK)								
Butyl acetate CH <sub>3</sub> CO <sub>2</sub> (CH <sub>2</sub> ) <sub>3</sub> CH <sub>3</sub>	142	Butyl acetate	0.05-0.8%	2	Orange	Dark green	3	T	150
	142L	Butyl acetate	10-300	2	Yellow	Dark Brown	2	T	
tert-Butyl alcohol (CH <sub>3</sub> ) <sub>3</sub> COH	102L	Hexane	500-12000	2	Orange	Dark green	3		100
Butyl acrylate CH <sub>2</sub> :CHCO <sub>2</sub> C <sub>4</sub> H <sub>9</sub>	142L	Butyl acetate	7-210	2	Yellow	Dark brown	2	T	2
Butylamine CH <sub>3</sub> (CH <sub>2</sub> ) <sub>3</sub> NH <sub>2</sub>	180	Amines	8-160	1	Pink	Grayish red to Brown	3	T	C 5
	180L	Amines	0.55-11	1	Pink	Pale orange	2	T	
tert-Butylamine (CH <sub>3</sub> ) <sub>3</sub> CNH <sub>2</sub>	180	Amines	5.5-110	1	Pink	Pale brown	3	T	
n-Butyl bromide C <sub>4</sub> H <sub>9</sub> Br	136H	Methyl bromide	24-360	1	White	Yellow	3	+	
	136L	Methyl bromide	10-100	1	White	Yellow	2	+	
	136LA	Methyl bromide	2.4-43.2	1	White	Yellow	2	+	
1-18			2						
Butyl mercaptan CH <sub>3</sub> (CH <sub>2</sub> ) <sub>3</sub> SH	70L	Mercaptans	6.4-12.8	1/2	Yellow	Red	2		0.5
			0.8-6.4	1					
			0.32-0.8	2					
			0.16-0.32	4					
tert-Butyl mercaptan (CH <sub>3</sub> ) <sub>3</sub> CSH	75	tert-Butyl mercaptan	60-150mg/m <sup>3</sup>	1/2	Yellow	Red	2	T	
			30-60mg/m <sup>3</sup>	1					
			2.5-30mg/m <sup>3</sup>	②					
	75L	tert-Butyl mercaptan	15-30mg/m <sup>3</sup>	1/2	Yellow	Pink	2*	T	
			1-15mg/m <sup>3</sup>	①					
			0.5-1mg/m <sup>3</sup>	2					
	77	TBM and DMS	1-15mg/m <sup>3</sup>	1	Yellow	Pink	2*	+T	
70L	Mercaptans	4-8	1/2	Yellow	Red	2			
		0.5-4	1						
		0.2-0.5	2						
		0.1-0.2	4						

T: Temp Correction H: Humidity Correction +: Twin Tubes ++: Nine Tubes \* Refrigerated Storage Mesh: Correction Factor/Chart  
P: Use Pyrotec pyrolyzer No. 840 and GASTEC gas sampling pump.  
See page 36 for additional symbols and definitions.

Gas or Vapour to be Measured Chemical Formula	Tube No. & Name		Measuring Range (ppm)	No. of Pump Strokes	Colour Change		Shelf Life (year)	Note	TLV-TWA, C (ACGIH) (ppm)				
					Original	Stain							
Butyric acid CH <sub>3</sub> CH <sub>2</sub> CH <sub>2</sub> CO <sub>2</sub> H	81L	Acetic acid	0.325-13	1	Pink	Pale yellow	2*	T					
Butyronitrile CH <sub>3</sub> CH <sub>2</sub> CH <sub>2</sub> CN	191L	Acrylonitrile	6-180	1	Yellow	Pink	3	+					
Carbon dioxide CO <sub>2</sub>	2HH	Carbon dioxide	5-40% 2.5-5%	①② 1	Orange	Yellow	3		5000				
	2H	Carbon dioxide	10-20% 1-10% 0.5-1%	1/2 ① 2	White	Purple	3						
			3-6% 0.25-3% 0.13-0.25%	1/2 ① 2						White	Purple	3	
			300-5000	①									
	2LC	Carbon dioxide	2000-4000 100-2000	1/2 ①	Pale red	Yellow	2						
Carbon disulphide CS <sub>2</sub>	13M	Carbon disulphide	1600-4000 50-1600 20-50	1/2 ① 2	Purple	Yellow	3	+T	1				
	13	Carbon disulphide	50-100 2.5-50 1.25-2.5 0.63-1.25	1/2 ① 2 4	Blue	Yellow	3	+T					
			13L	Carbon disulphide						3.0-8.1 0.1-3.0	1 ②	Bluish purple	White
Carbon monoxide CO	1HH	Carbon monoxide	2-50% 1-2%	①② 1	White	Blackish brown	3		25				
	1H	Carbon monoxide	5-10% 0.2-5% 0.1-0.2%	1/2 ① 2	White	Blackish brown	3						
			2-4% 0.1-2% 0.05-0.1%	1/2 ① 2						White	Pale brown	3	
	1LM	Carbon monoxide	1000-2000 50-1000 25-50	1/2 ① 2	White	Pale brown/Pale green (dual layers)	3						
	1L	Carbon monoxide	1000-2000 25-1000 2.5-25	1/2 ① 2-10	Yellow	Blackish brown	3						
	1La	Carbon monoxide	500-1000 25-500 12.5-25 8-12.5	1/2 ① 2 3	Yellow	Blackish brown	3	T					
			300-600 (in Hydrogen)	1/2 1 ③						White	Pale brown/Pale green (dual layers)	3	
			5-100	③									
	1LKC	Carbon monoxide (in Hydrogen with Hydrocarbons)	5-100	③	White	Pale brown/Pale green (dual layers)	3	+					
	1LL	Carbon monoxide	5-50	2						Yellow	Blackish brown	3	
1LC	Carbon monoxide	1-30	1	White	Pale pink	2	T						

T: Temp Correction H: Humidity Correction +: Twin Tubes ++: Nine Tubes \* Refrigerated Storage Mesh: Correction Factor/Chart  
P: Use Pyrotec pyrolyzer No. 840 and GASTEC gas sampling pump.  
See page 36 for additional symbols and definitions.

Gas or Vapour to be Measured Chemical Formula	Tube No. & Name		Measuring Range (ppm)	No. of Pump Strokes	Colour Change		Shelf Life (year)	Note	TLV-TWA, C (ACGIH) (ppm)
					Original	Stain			
Carbon tetrachloride CCl <sub>4</sub>	134	Carbon tetrachloride	2.5-60 0.5-2.5	① 2-5	White	Yellow	1*	+	5
	134L	Carbon tetrachloride	5-12 0.25-5	1 ②	White	Yellow	1*	+	
Carbonyl chloride	See Phosgene								
Carbonyl sulphide COS	21	Carbonyl sulphide	100-200 10-100 5-10	1/2 ① 2	Blue	Yellow	2*	+	5
	21LA	Carbonyl sulphide	50-125 5-50 2-5	1/2 ① 2	Bluish purple	White	2*	+T	
Chlorine Cl <sub>2</sub>	8HH	Chlorine	0.5-10% 0.25-0.5%	①② 1	Reddish purple	Yellow	3		0.5
	8H	Chlorine	500-1000 50-500 25-50	1/2 ① 2	White	Vermilion	3		
	8La	Chlorine	8-16 0.5-8 0.1-0.5	1/2 ① 2-5	White	Pale pink	3		
	8LL	Chlorine	1-2 0.05-1 0.025-0.05	1/2 ① 2	White	Pale green	1*		
	80	Acid gases	0.7-14	2	Pale bluish purple	White	2		
Chlorine dioxide ClO <sub>2</sub>	23M	Chlorine dioxide	5-10 0.5-5 0.1-0.5	1/2 ① 2-5	White	Pale pink	3		0.1
	23L	Chlorine dioxide	0.6-1.2 0.05-0.6 0.025-0.05	1/2 ① 2	White	Pale green	1*		
	8H	Chlorine	25-250	1	White	Vermilion	3		
	8La	Chlorine	0.3-4.8	1	White	Pale pink	3		
Chlorobenzene C <sub>6</sub> H <sub>5</sub> Cl	126	Chlorobenzene	200-500 5-200 2-5	1/2 ① 2	White	Gray	3		10
	126L	Chlorobenzene	10-43 0.5-10	1 ③	Yellow	Pale purple	2*	T	
Chlorobromomethane CH <sub>2</sub> BrCl	135	1,1,1-Trichloroethane (Methyl chloroform)	22-110	1	White	Reddish orange	3	+T	200
	136H	Methyl bromide	18-270	1	White	Yellow	3	+	
	136L	Methyl bromide	11-110	1	White	Yellow	2	+	
	136LA	Methyl bromide	0.7-12.6	2	White	Yellow	2	+	
Chlorocyclohexane C <sub>6</sub> H <sub>11</sub> Cl	102L	Hexane	50-1200	2	Orange	Dark green	3		
Chlorodifluoromethane (R22) CHClF <sub>2</sub>	51H	Fluorochlorocarbons (Pyrotec tube)	0.8-2.4% 0.1-0.8%	1/2 1	White	Reddish orange	3	+P	1000
	51	Fluorochlorocarbons (Pyrotec tube)	25-1000	1	Yellow	Reddish purple	3	+P	
	51L	Fluorochlorocarbons (Pyrotec tube)	50-135 2.5-50	1 2	Yellow	Reddish purple	3	+P	
1-Chloro-2,3-epoxy propane	See Epichlorohydrin								
2-Chloroethanol	See Ethylene chlorohydrin								

T: Temp Correction H: Humidity Correction +: Twin Tubes ++: Nine Tubes \* Refrigerated Storage Mesh: Correction Factor/Chart  
P: Use Pyrotec pyrolyzer No. 840 and GASTEC gas sampling pump.  
See page 36 for additional symbols and definitions.



Gas or Vapour to be Measured Chemical Formula	Tube No. & Name		Measuring Range (ppm)	No. of Pump Strokes	Colour Change		Shelf Life (year)	Note	TLV-TWA, C (ACGIH) (ppm)
					Original	Stain			
Chloroethylene	See Vinyl chloride								
Chloroform CHCl <sub>3</sub>	137	Chloroform	100-400	3	White	Orange	3	+H	10
			10-100	⑤					
			4-10	7					
137LA	Chloroform	12-30	1	White	Pale purple	1*	+T		
		2-12	②						
0.5-2	4								
137LL	Chloroform	0.3-4.5	④	White	Pale purple	1*	+T		
Chloropicrin Cl <sub>3</sub> CNO <sub>2</sub>	134	Carbon tetrachloride	2.5-60	1	White	Yellow	1*	+	0.1
	134L	Carbon tetrachloride	0.125-2.5	2	White	Yellow	1*	+	
	233	Chloropicrin	10-22	1/2	White	Yellow	1	+	
0.1-10			1						
0.045-0.1			2						
2-Chloro-1,1,1,2-tetrafluoroethane(R124) CHClF <sub>2</sub> CF <sub>3</sub>	51	Fluorochlorocarbons (Pyrotec tube)	45-1800	1	Yellow	Reddish purple	3	+P	
m-Cresol C <sub>6</sub> H <sub>4</sub> (CH <sub>3</sub> )OH	61	o-Cresol	1-25	2	Pale yellow	Gray	2*	T	20mg/m <sup>3</sup> (IFV)
o-Cresol C <sub>6</sub> H <sub>4</sub> (CH <sub>3</sub> )OH	61	o-Cresol	25-62.5	1	Pale yellow	Gray	2*	T	20mg/m <sup>3</sup> (IFV)
			1-25	②					
			0.4-1	4					
p-Cresol C <sub>6</sub> H <sub>4</sub> (CH <sub>3</sub> )OH	61	o-Cresol	1-25	2	Pale yellow	Gray	2*	T	20mg/m <sup>3</sup> (IFV)
Cumene C <sub>6</sub> H <sub>5</sub> CH(CH <sub>3</sub> ) <sub>2</sub>	122L	Toluene	2-100	2	White	Brown	3		50
Cyclohexane C <sub>6</sub> H <sub>12</sub>	102H	Hexane	0.6-1.2%	1/2	Orange	Dark green	3		100
			0.03-0.6%	1					
			0.015-0.03%	2					
102L	Hexane	60-1440	1	Orange	Dark green	3			
Cyclohexanol C <sub>6</sub> H <sub>11</sub> OH	118	Cyclohexanol	5-100	2	Yellow	Pale blue	2	T	50
Cyclohexanone C <sub>6</sub> H <sub>10</sub> O	154	Cyclohexanone	30-75	2	Pale yellow	Yellow	2*	T	20
	91L	Formaldehyde	10-470	1/2					
Cyclohexene C <sub>6</sub> H <sub>10</sub>	151	Acetone	0.05-0.8%	1	Orange	Brownish green	3	T	300
Cyclohexylamine C <sub>6</sub> H <sub>13</sub> N	180	Amines	7-140	1	Pink	Salmon pink	3	T	10
	180L	Amines	0.5-10	1	Pink	Pale orange	2	T	
Cymene C <sub>10</sub> H <sub>14</sub>	141L	Ethyl acetate	5.6-224	2	Yellow	Blackish brown	2	T	
n-Decane CH <sub>3</sub> (CH <sub>2</sub> ) <sub>8</sub> CH <sub>3</sub>	105	Hydrocarbons (Higher class)	400-6000	1	White	Blackish brown	3		
			200-400	2					
Diacetone alcohol (CH <sub>3</sub> ) <sub>2</sub> C(OH)CH <sub>2</sub> COCH <sub>3</sub>	154	Cyclohexanone	2.5-100	2	Pale yellow	Yellow	2*	T	50
Diacetyl CH <sub>3</sub> COCOCCH <sub>3</sub>	92	Acetaldehyde	25-1500	3	Yellow	Red	2*	T	0.01
1,2-Diaminoethane	See Ethylenediamine								
Diborane B <sub>2</sub> H <sub>6</sub>	22	Diborane	2-5	1	Yellow	Red	2	T	0.1
			0.05-2	②					
			0.02-0.05	5					

T: Temp Correction H: Humidity Correction +: Twin Tubes ++: Nine Tubes \* Refrigerated Storage Mesh: Correction Factor/Chart  
P: Use Pyrotec pyrolyzer No. 840 and GASTEC gas sampling pump.  
See page 36 for additional symbols and definitions.

Gas or Vapour to be Measured Chemical Formula	Tube No. & Name		Measuring Range (ppm)	No. of Pump Strokes	Colour Change		Shelf Life (year)	Note	TLV-TWA, C (ACGIH) (ppm)
					Original	Stain			
1,1-Dibromoethane CH <sub>3</sub> CHBr <sub>2</sub>	136L	Methyl bromide	7-70	1	White	Yellow	2	+	
1,2-Dibromoethane	See Ethylene dibromide								
Dibromomethane CH <sub>2</sub> Br <sub>2</sub>	136L	Methyl bromide	5-50	1	White	Yellow	2	+	
Di-n-butylamine (CH <sub>3</sub> CH <sub>2</sub> CH <sub>2</sub> CH <sub>2</sub> ) <sub>2</sub> NH	180	Amines	5-100	1	Pink	Pale orange	3	T	
	180L	Amines	0.4-8	1	Pink	Pale orange	2	T	
m-Dichlorobenzene C <sub>6</sub> H <sub>4</sub> Cl <sub>2</sub>	127	o-Dichlorobenzene	2.5-300	2	White	Light brown	3	T	
o-Dichlorobenzene C <sub>6</sub> H <sub>4</sub> Cl <sub>2</sub>	127	o-Dichlorobenzene	2.5-300	2	White	Light brown	3	T	25
p-Dichlorobenzene C <sub>6</sub> H <sub>4</sub> Cl <sub>2</sub>	127	o-Dichlorobenzene	2.5-300	2	White	Light brown	3	T	10
Dichlorodifluoromethane (R12) CCl <sub>2</sub> F <sub>2</sub>	51H	Fluorochlorocarbons (Pyrotec tube)	2600-7800 325-2600	1/2 1	White	Reddish orange	3	+P	1000
	51	Fluorochlorocarbons (Pyrotec tube)	11-440	1	Yellow	Reddish purple	3	+P	
	51L	Fluorochlorocarbons (Pyrotec tube)	36-97.2 1.8-36	1 2	Yellow	Reddish purple	3	+P	
1,1-Dichloroethane CH <sub>3</sub> CHCl <sub>2</sub>	135	1,1,1-Trichloroethane (Methyl chloroform)	90-450	1	White	Reddish orange	3	+T	100
1,2-Dichloroethane	See Ethylene dichloride								
1,1-Dichloroethylene	See Vinylidene chloride								
1,2-Dichloroethylene ClCH:CHCl	139	1,2-Dichloroethylene	100-250 10-100 5-10	1/2 ① 2	Yellow	Reddish purple	2*	T	200
	132HA	Trichloroethylene	80-800	1	Yellow	Reddish purple	2*	T	
	132LL	Trichloroethylene	0.375-6.0	1	Yellow	Purple	2*	T	
1,1-Dichloro-1-fluoroethane (R141b) CH <sub>3</sub> CCl <sub>2</sub> F	51	Fluorochlorocarbons (Pyrotec tube)	400-1000 10-400	1/2 1	Yellow	Reddish purple	3	+P	
	51L	Fluorochlorocarbons (Pyrotec tube)	1.1-22	2	Yellow	Reddish purple	3	+P	
Dichloromethane	See Methylene chloride								
Dichloropentafluoropropane (R225)	51	Fluorochlorocarbons (Pyrotec tube)	20-800	1	Yellow	Reddish purple	3	+P	
	51L	Fluorochlorocarbons (Pyrotec tube)	1.4-28	2	Yellow	Reddish purple	3	+P	
3,3-Dichloro-1,1,2,2-pentafluoropropane (R225ca) CHCl <sub>2</sub> CF <sub>2</sub> CF <sub>3</sub>	51	Fluorochlorocarbons (Pyrotec tube)	20-800	1	Yellow	Reddish purple	3	+P	
	51L	Fluorochlorocarbons (Pyrotec tube)	1.4-28	2	Yellow	Reddish purple	3	+P	
1,2-Dichloropropane	See Propylene dichloride								
1,3-Dichloropropene ClCH <sub>2</sub> CH:CHCl	132HA	Trichloroethylene	45-450	2	Yellow	Reddish purple	2*	T	1
	131La	Vinyl chloride	0.5-10	2	Yellow	Reddish brown	2*	+	
1,2-Dichloro-1,1,2,2-tetrafluoroethane (R114) CClF <sub>2</sub> CCF <sub>2</sub>	51H	Fluorochlorocarbons (Pyrotec tube)	3800-11400 475-3800	1/2 1	White	Reddish orange	3	+P	1000
	51	Fluorochlorocarbons (Pyrotec tube)	20-800	1	Yellow	Reddish purple	3	+P	
	51L	Fluorochlorocarbons (Pyrotec tube)	36-97.2 1.8-36	1 2	Yellow	Reddish purple	3	+P	

T: Temp Correction H: Humidity Correction +: Twin Tubes ++: Nine Tubes \* Refrigerated Storage Mesh: Correction Factor/Chart  
P: Use Pyrotec pyrolyzer No. 840 and GASTEC gas sampling pump.  
See page 36 for additional symbols and definitions.

Gas or Vapour to be Measured Chemical Formula	Tube No. & Name		Measuring Range (ppm)	No. of Pump Strokes	Colour Change		Shelf Life (year)	Note	TLV-TWA, C (ACGIH) (ppm)		
					Original	Stain					
2,2-Dichloro-1,1,1-trifluoroethane (R123) CHCl <sub>2</sub> CF <sub>3</sub>	51	Fluorochlorocarbons (Pyrotec tube)	560-1600 14-560	1/2 1	Yellow	Reddish purple	3	+P			
	51L	Fluorochlorocarbons (Pyrotec tube)	1.4-28	2	Yellow	Reddish purple	3	+P			
Dichlorvos C <sub>4</sub> H <sub>7</sub> Cl <sub>2</sub> O <sub>4</sub> P	132LL	Trichloroethylene	0.11-1.8	2	Yellow	Purple	2*	T	0.1mg/m <sup>3</sup> (FV)		
Diethylamine (C <sub>2</sub> H <sub>5</sub> ) <sub>2</sub> NH	180	Amines	5.5-110	1	Pink	Pale Brown	3	T	5		
	180L	Amines	0.45-9	1	Pink	Pale orange	2	T			
Diethylaminoethanol (C <sub>2</sub> H <sub>5</sub> )NCH <sub>2</sub> CH <sub>2</sub> OH	180L	Amines	0.6-12	1	Pink	Pale orange	2	T	2		
Diethyl benzene C <sub>6</sub> H <sub>4</sub> (C <sub>2</sub> H <sub>5</sub> ) <sub>2</sub>	122L	Toluene	2-150	4	White	Brown	3				
Diethylenetriamine H <sub>2</sub> NCH <sub>2</sub> CH <sub>2</sub> NHCH <sub>2</sub> CH <sub>2</sub> NH <sub>2</sub>	180L	Amines	0.95-19	1	Pink	Grayish purple (Pale orange at the end of staining)*	2	T	1		
Diethylethanolamine (C <sub>2</sub> H <sub>5</sub> ) <sub>2</sub> NC <sub>2</sub> H <sub>4</sub> OH	180	Amines	6-120	1	Pink	Pale brown	3	T	2		
Diethyl ether	See Ethyl ether										
Diisobutylene (CH <sub>3</sub> ) <sub>3</sub> CCH:C(CH <sub>3</sub> ) <sub>2</sub>	121	Benzene	45-540	1	White	Dark green	3				
Diisobutyl ketone [(CH <sub>3</sub> ) <sub>2</sub> CHCH <sub>2</sub> ] <sub>2</sub> CO	102L	Hexane	0.2-1%	2	Orange	Dark green	3		25		
	91L	Formaldehyde	0.58-29	4	Yellow	Reddish brown	3*	T			
Diisopropylamine [(CH <sub>3</sub> ) <sub>2</sub> CH] <sub>2</sub> NH	180	Amines	5-100	1	Pink	Pale orange	3	T	5		
	180L	Amines	0.3-6	1	Pink	Pale orange	2	T			
Diisopropyl benzene C <sub>6</sub> H <sub>5</sub> N [CH(CH <sub>3</sub> ) <sub>2</sub> ] <sub>2</sub>	141L	Ethyl acetate	10-400	1/2	Yellow	Blackish brown	2	T			
N,N-Dimethyl acetamide CH <sub>3</sub> CON(CH <sub>3</sub> ) <sub>2</sub>	184	N,N-Dimethyl acetamide	60-240	1	Pink	Pale yellow	3	T	10		
			5-60	②							
			1.5-5	4							
Dimethylamine (CH <sub>3</sub> ) <sub>2</sub> NH	3H	Ammonia	1.2-19.2%	1	Purple	Yellow	3		5		
			180	Amines	5.5-110	1	Pink	Salmon pink		3	T
			180L	Amines	0.45-9	1	Pink	Pale orange		2	T
2-Dimethylaminoethanol (CH <sub>3</sub> ) <sub>2</sub> NCH <sub>2</sub> CH <sub>2</sub> OH	180L	Amines	0.65-13	1	Pink	Pale orange	2	T			
Dimethylaminopropylamine (CH <sub>3</sub> ) <sub>2</sub> NCH <sub>2</sub> CH <sub>2</sub> CH <sub>2</sub> NH <sub>2</sub>	180	Amines	8-160	1	Pink	Grayish red	3	T			
	180L	Amines	0.6-12	1	Pink	Pale orange	2	T			
N,N-Dimethylaniline C <sub>6</sub> H <sub>5</sub> N(CH <sub>3</sub> ) <sub>2</sub>	181	Aniline	2.5-30	3	Pale yellow	Pale green	3		5		
Dimethylbenzene	See Xylene										
Dimethyl disulphide (CH <sub>3</sub> ) <sub>2</sub> S <sub>2</sub>	53	Dimethyl sulphide (Pyrotec tube)	0.3-6	3	Bluish purple	White	2	+TP	0.5		
Dimethylethanolamine (CH <sub>3</sub> ) <sub>2</sub> NCH <sub>2</sub> CH <sub>2</sub> OH	180	Amines	6.5-130	1	Pink	Pale orange to Yellow	3	T			
	180L	Amines	0.65-13	1	Pink	Pale orange	2	T			
N,N-Dimethylethylamine C <sub>2</sub> H <sub>5</sub> N(CH <sub>3</sub> ) <sub>2</sub>	180	Amines	4-80	1	Pink	Yellow	3	T			
	180L	Amines	0.3-6	1	Pink	Pale orange	2	T			
N,N-Dimethyl formamide HCON(CH <sub>3</sub> ) <sub>2</sub>	183	N,N-Dimethyl formamide	30-90	1/2	Pink	Pale red	3	T	10		
			2-30	①							
			0.8-2	2							
2,6-Dimethyl-4-heptanone	See Diisobutyl ketone										
Dimethylhydrazine NH <sub>2</sub> N(CH <sub>3</sub> ) <sub>2</sub>	185	Hydrazine	0.1-2	5	Pink	Yellow	3	H	0.01		

T: Temp Correction H: Humidity Correction +: Twin Tubes ++: Nine Tubes \* Refrigerated Storage Mesh: Correction Factor/Chart

P: Use Pyrotec pyrolyzer No. 840 and GASTEC gas sampling pump. \*: Pale orange when low concentration

See page 36 for additional symbols and definitions.

Gas or Vapour to be Measured Chemical Formula	Tube No. & Name		Measuring Range (ppm)	No. of Pump Strokes	Colour Change		Shelf Life (year)	Note	TLV-TWA, C (ACGIH) (ppm)
					Original	Stain			
Dimethyl sulphide (CH <sub>3</sub> ) <sub>2</sub> S	53	Dimethyl sulphide (Pyrotec tube)	0.5-10 0.25-0.5	③ 5	Bluish purple	White	2	+T	10
	77	TBM and DMS	1-15mg/m <sup>3</sup>	1	Pink	Pale yellow	2*	+	
1,4-Dioxane C <sub>4</sub> H <sub>8</sub> O <sub>2</sub>	159	Tetrahydrofuran	25-140	2	Pink	Pale blue	3	T	20
	163	Ethylene oxide	0.1-6.0%	1	Orange	Green	3		
Dipropylamine (CH <sub>3</sub> CH <sub>2</sub> CH <sub>2</sub> ) <sub>2</sub> NH	180	Amines	4-80	1	Pink	Yellow	3	T	
	180L	Amines	0.35-7	1	Pink	Pale orange	2	T	
Divinyl benzene C <sub>6</sub> H <sub>4</sub> (CH:CH <sub>2</sub> ) <sub>2</sub>	124L	Styrene	1-15	3	White	Yellow	3		10
Divinyl methoxysilane (CH <sub>2</sub> :CH <sub>2</sub> ) <sub>2</sub> CH <sub>3</sub> OSi	113L	Isopropyl alcohol	6.5-25.0	2	Pink	Pale blue	3	T	
Enflurane (2-Chloro-1,1,2-Trifluoroethyl Difluoromethyl Ether) CHClFCH <sub>2</sub> OCHF <sub>2</sub>	51	Fluorochlorocarbons (Pyrotec tube)	20-1200	1	Yellow	Reddish purple	3	+P	75
	51L	Fluorochlorocarbons (Pyrotec tube)	25-145	2	Yellow	Reddish purple	3	+P	
Epichlorohydrin CH <sub>2</sub> OCHCH <sub>2</sub> Cl	163L	Ethylene oxide	1.2-120	2	Yellow	Reddish brown	1*	+T	0.5
1,2-Epoxypropane	See Propylene oxide								
Ethanthiol	See Ethyl mercaptan								
Ethanol C <sub>2</sub> H <sub>5</sub> OH	112	Ethanol	2.5-7.5%	1/2	Pink	Pale blue	3	T	
			0.05-2.5%	①					
			0.01-0.05%	2					
	112L	Ethanol	100-2000 50-100	① 2	Pink	Pale blue	3	T	
Ethyl alcohol	See Ethanol								
Ethanalamine H <sub>2</sub> NCH <sub>2</sub> CH <sub>2</sub> OH	180	Amines	7-140	3	Pink	Yellow	3	T	3
	180L	Amines	1.95-39	1	Pink	Grayish purple (Pale orange at the end of staining)*	2	T	
Ethyl acetate CH <sub>3</sub> CO <sub>2</sub> C <sub>2</sub> H <sub>5</sub>	141	Ethyl acetate	0.1-1.5%	1	Orange	Dark green	3	T	400
	141L	Ethyl acetate	20-800	2	Yellow	Blackish brown	2	T	
Ethyl acrylate CH <sub>2</sub> :CHCO <sub>2</sub> C <sub>2</sub> H <sub>5</sub>	141L	Ethyl acetate	8-320	2	Yellow	Blackish brown	2	T	5
Ethylamine C <sub>2</sub> H <sub>5</sub> NH <sub>2</sub>	180	Amines	5-100	1	Pink	Yellow	3	T	5
	180L	Amines	0.45-9	1	Pink	Pale orange	2	T	
Ethyl benzene C <sub>6</sub> H <sub>5</sub> C <sub>2</sub> H <sub>5</sub>	122	Toluene	11-330	1	White	Brown	3		20
	122L	Toluene	1-70	2	White	Brown	3		
p-Ethyl benzylchloride C <sub>6</sub> H <sub>4</sub> (C <sub>2</sub> H <sub>5</sub> )CH <sub>2</sub> Cl	131La	Vinyl chloride	2.5-50	2	Yellow	Reddish brown	2*	+	
Ethyl bromide C <sub>2</sub> H <sub>5</sub> Br	136L	Methyl bromide	100-200	1/2	White	Yellow	2	+	5
			10-100	①					
			2.5-10	4					
Ethyl chloroformate ClCO <sub>2</sub> C <sub>2</sub> H <sub>5</sub>	131La	Vinyl chloride	7-140	2	Yellow	Reddish brown	2*	+	
Ethyl chloride C <sub>2</sub> H <sub>5</sub> Cl	138	Methylene chloride	15-150	1	White	Pale pink	3	+T	100
Ethylene CH <sub>2</sub> :CH <sub>2</sub>	172	Ethylene	800-1680	1/2	Pale yellow	Blue	3	T	200
			25-800	①					
	172L	Ethylene	50-100	2	Pale yellow	Blue	3	T	
			0.2-50	④					
103	Hydrocarbons (Lower class)	8.4-16.8%	1/2	Yellowish brown	Greenish brown	2	++		
		0.1-8.4%	1						
		0.35-0.7%	2						

T: Temp Correction H: Humidity Correction +: Twin Tubes ++: Nine Tubes \* Refrigerated Storage Mesh: Correction Factor/Chart  
P: Use Pyrotec pyrolyzer No. 840 and GASTEC gas sampling pump. ※1: Pale orange when low concentration  
See page 36 for additional symbols and definitions.

Gas or Vapour to be Measured Chemical Formula	Tube No. & Name		Measuring Range (ppm)	No. of Pump Strokes	Colour Change		Shelf Life (year)	Note	TLV-TWA, C (ACGIH) (ppm)
					Original	Stain			
Ethylene CH <sub>2</sub> :CH <sub>2</sub>	171	Acetylene	0.1-2.0%	1	White	Brown	3	T	200
Ethylene chlorohydrin ClCH <sub>2</sub> CH <sub>2</sub> OH	111L	Methanol	80-200	3	Pink	Pale blue	3	T	C 1
Ethylenediamine H <sub>2</sub> NCH <sub>2</sub> CH <sub>2</sub> NH <sub>2</sub>	180	Amines	14-280	1	Pink	Yellow	3	T	10
	180L	Amines	0.9-18	1	Pink	Pale orange	2	T	
Ethylene dibromide BrCH <sub>2</sub> CH <sub>2</sub> Br	136H	Methyl bromide	14-210	1	White	Yellow	3	+	
	136L	Methyl bromide	8-80	1	White	Yellow	2	+	
Ethylene dichloride ClCH <sub>2</sub> CH <sub>2</sub> Cl	232	1,2-Dichloroethane	15-39 1-15	1 ②	White	Pale purple	1*	+T	10
	135	1,1,1-Trichloroethane (Methyl chloroform)	400-2000	1	White	Reddish orange	3	+T	
	135L	1,1,1-Trichloroethane (Methyl chloroform)	104-1040	1	White	Pale pink	2	+T	
Ethylene glycol HOCH <sub>2</sub> CH <sub>2</sub> OH	165L	Ethylene glycol	10-100mg/m <sup>3</sup>	2	Yellow	Reddish brown	3*	+T	C 100mg/m <sup>3</sup>
Ethylene glycol monobutyl ether CH <sub>2</sub> (CH <sub>2</sub> ) <sub>3</sub> OCH <sub>2</sub> CH <sub>2</sub> OH	113L	Isopropyl alcohol	200-1000	2	Pink	Pale blue	3	T	20
	113LL	Isopropyl alcohol	60-400	2	Pink	Pale blue	2	T	
Ethylene glycol monoethyl ether C <sub>2</sub> H <sub>5</sub> OCH <sub>2</sub> CH <sub>2</sub> OH	113L	Isopropyl alcohol	110-1000	2	Pink	Pale blue	3	T	5
	113LL	Isopropyl alcohol	46-460	2	Pink	Pale blue	2	T	
Ethylene glycol monomethyl ether CH <sub>3</sub> OCH <sub>2</sub> CH <sub>2</sub> OH	113L	Isopropyl alcohol	75-760	2	Pink	Pale blue	3	T	0.1
	113LL	Isopropyl alcohol	44-440	2	Pink	Pale blue	2	T	
Ethylene glycol monomethyl ether acetate	See 2-Methoxyethyl acetate								
Ethylene oxide C <sub>2</sub> H <sub>4</sub> O	163	Ethylene oxide	0.05-3.0%	1	Orange	Green	3		1
	163L	Ethylene oxide	100-350	1	Yellow	Reddish brown	1*	+T	
			1-100 0.4-1	② 4					
163LL	Ethylene oxide	5-10 0.1-5	2 ④	Yellow	Pale orange	1*	+T		
Ethyl ether (C <sub>2</sub> H <sub>5</sub> ) <sub>2</sub> O	161	Ethyl ether	0.04-1.0%	1	Orange	Dark green	3	T	400
	161L	Ethyl ether	400-1200 10-400	1 ②	Yellow	Pale blue	2	T	
Ethylidene chloride	See 1,1-Dichloroethane								
Ethyl mercaptan C <sub>2</sub> H <sub>5</sub> SH	72	Ethyl mercaptan	5-120	①	White	Yellow	3	T	0.5
			0.5-5	2-10					
	72L	Ethyl mercaptan	30-75	1/2	Yellow	Red	2	T	
			0.5-30	①					
			0.2-0.5	2					
	70	Mercaptans	5-120	1	White	Yellow	3	T	
0.5-5			2-10						
70L	Mercaptans	4-8	1/2	Yellow	Red	2			
		0.5-4	1						
		0.2-0.5	2						
		0.1-0.2	4						
71H	Methyl mercaptan	100-3800	1	White	Yellow	3			
N-Ethyl morpholine C <sub>6</sub> H <sub>13</sub> NO	180	Amines	5-100	1	Pink	Yellow	3	T	5
	180L	Amines	0.3-6	1	Pink	Pale orange	2	T	
Fluorine F <sub>2</sub>	17	Hydrogen fluoride	0.5-50	1	Yellow	Brown	3	H	1
Fluorotrichloromethane	See Trichlorofluoromethane (R11)								

T: Temp Correction H: Humidity Correction +: Twin Tubes ++: Nine Tubes \* Refrigerated Storage Mesh: Correction Factor/Chart  
P: Use Pyrotec pyrolyzer No. 840 and GASTEC gas sampling pump.  
See page 36 for additional symbols and definitions.

Gas or Vapour to be Measured Chemical Formula	Tube No. & Name		Measuring Range (ppm)	No. of Pump Strokes	Colour Change		Shelf Life (year)	Note	TLV-TWA, C (ACGIH) (ppm)
					Original	Stain			
Formaldehyde HCHO	91M	Formaldehyde	2000-6400	1/2	Yellow	Red	2*	T	C 0.3
			20-2000	①					
	8-20	2							
	91	Formaldehyde	50-100	1/2	White	Brown	3	+	
20-50			1						
2-20	②								
91L	Formaldehyde	5-40	1	Yellow	Reddish brown	3*	T		
0.1-5	⑤								
Formic acid HCO <sub>2</sub> H	81	Acetic acid	5.2-130	1	Pink	Yellow	3	H	5
	81L	Acetic acid	0.5-20	1	Pink	Yellow	2*	T	
Furfural C <sub>5</sub> H <sub>4</sub> O <sub>2</sub>	154	Cyclohexanone	2-30	4	Pale yellow	Yellow	2*	T	2
Gasoline (Petrol) C <sub>n</sub> H <sub>m</sub>	101	Gasoline (Petrol)	0.6-1.2%	1/2	Orange	Dark green	3		300
			0.03-0.6%	①					
	0.015-0.03%	2							
101L	Gasoline (Petrol)	1000-2000	1	Orange	Dark green	3			
30-1000	②								
1M	Carbon monoxide	0.1-2%	1	White	Pale brown	3			
Halothane (2-Bromo-2-chloro-1,1,1 - trifluoroethane) CF <sub>3</sub> CHBrCl	51H	Fluorochlorocarbons (Pyrotec tube)	800-6400	1	White	Reddish orange	3	+P	50
	51	Fluorochlorocarbons (Pyrotec tube)	240-960	1	Yellow	Reddish purple	3	+P	
	51L	Fluorochlorocarbons (Pyrotec tube)	3-60	2	Yellow	Reddish purple	3	+P	
Heptane CH <sub>3</sub> (CH <sub>2</sub> ) <sub>5</sub> CH <sub>3</sub>	101	Gasoline (Petrol)	0.6-1.2%	1/2	Orange	Dark green	3		400
			0.03-0.6%	1					
	0.015-0.03%	2							
	101L	Gasoline (Petrol)	1000-2000	1	Orange	Dark green	3		
30-1000			2						
103	Hydrocarbons (Lower class)	0.84-1.68%	1/2	Yellowish brown	Greenish brown	2	++		
		0.07-0.84%	1						
0.035-0.07%	2								
105	Hydrocarbons (Higher class)	180-2700	1	White	Blackish brown	3			
		90-180	2						
Hexamethylenediamine H <sub>2</sub> N(CH <sub>2</sub> ) <sub>6</sub> NH <sub>2</sub>	180L	Amines	1.55-31	1	Pink	Grayish purple (Pale orange at the end of staining)*	2	T	0.5
Hexane CH <sub>3</sub> (CH <sub>2</sub> ) <sub>4</sub> CH <sub>3</sub>	102H	Hexane	0.6-1.2%	1/2	Orange	Dark green	3		50
			0.03-0.6%	①					
	0.015-0.03%	2							
	102L	Hexane	50-1200	①	Orange	Dark green	3		
4-50			5						
103	Hydrocarbons (Lower class)	0.6-1.2%	1/2	Yellowish brown	Greenish brown	2	++		
		0.05-0.6%	1						
0.025-0.05%	2								
105	Hydrocarbons (Higher class)	160-2400	1	White	Blackish brown	3			
		80-160	2						
Hexone	See Methyl isobutyl ketone								
2-Hexyl alcohol CH <sub>3</sub> (CH <sub>2</sub> ) <sub>5</sub> CH(OH)CH <sub>3</sub>	141L	Ethyl acetate	60-2400	3	Yellow	Blackish brown	2	T	

T: Temp Correction H: Humidity Correction +: Twin Tubes ++: Nine Tubes \* Refrigerated Storage Mesh: Correction Factor/Chart  
P: Use Pyrotec pyrolyzer No. 840 and GASTEC gas sampling pump. ※1: Pale orange when low concentration  
See page 36 for additional symbols and definitions.

Gas or Vapour to be Measured Chemical Formula	Tube No. & Name		Measuring Range (ppm)	No. of Pump Strokes	Colour Change		Shelf Life (year)	Note	TLV-TWA, C (ACGIH) (ppm)
					Original	Stain			
Hexylamine CH <sub>3</sub> (CH <sub>2</sub> ) <sub>5</sub> NH <sub>2</sub>	180	Amines	9-180	1	Pink	Pale orange	3	T	
	180L	Amines	0.65-13	1	Pink	Pale orange	2	T	
Hydrazine N <sub>2</sub> H <sub>4</sub>	185	Hydrazine	0.1-2 0.05-0.1	⑤ 10	Pink	Yellow	3	H	0.01
Hydrocarbons (Higher Class)	105	Hydrocarbons (Higher class)	200-3000 100-200	① 2	White	Blackish brown	3		
Hydrocarbons (Lower Class)	103	Hydrocarbons (Lower class)	1.2-2.4% 0.1-1.2% 0.05-0.1%	1/2 ① 2	Yellowish brown	Greenish brown	2	++	
Hydrogen H <sub>2</sub>	30	Hydrogen	0.5-2%	1	Yellow	Yellowish brown	3		
Hydrogen bromide HBr	15L	Nitric acid	0.8-16	1	Yellow	Reddish purple	3	H	C 2
Hydrogen chloride HCl	14R	Hydrogen chloride (for Low Humidity)	200-5000 50-200	① 2-4	Purple	※2 Yellow/Pale pink	3		C 2
	14M	Hydrogen chloride	500-1000 20-500 10-20	1/2 ① 2	Yellow	Red	3		
	14L	Hydrogen chloride	20-76 1-20 0.2-1	1/2 ① 2-5	Yellow	Pink	3		
	80	Acid gases	8-160	2	Pale bluish purple	Pale red purple	2		
	8HH	Chlorine	1.5-30%	1/2	Reddish purple	Yellow	3		
Hydrogen cyanide HCN	12H	Hydrogen cyanide	0.05-1.6%	1	Yellow	White	3	T	C 4.7
	12M	Hydrogen cyanide	800-2400	1/2	Yellow	Red	3		
			50-800	①					
			17-50	2					
12L	Hydrogen cyanide	60-150	1/2	Yellow	Pink	2	T		
		2.5-60	①						
		1.25-2.5	2						
		0.5-1.25	5						
12LL	Hydrogen cyanide	5-10 0.2-5	1 ②	Yellow	Pink	2			
Hydrogen fluoride HF	17	Hydrogen fluoride	20-100 0.5-20 0.25-0.5	1 ④ 7	Yellow	※3 Brown / Deep pink	3	H	0.5
	17L	Hydrogen fluoride	10-72 0.2-10 0.09-0.2	1 ③ 5	Yellow	Brown	2	H	
	17LL	Hydrogen fluoride	6.9-24 3.0-6.9 0.05-3.0	1 3 ⑤	Yellow	Brown	2	TH	
Hydrogen peroxide H <sub>2</sub> O <sub>2</sub>	32	Hydrogen peroxide	0.5-10	5	White	Yellow	3	T	1
Hydrogen sulphide H <sub>2</sub> S	4HT	Hydrogen sulphide	20-40% 2-20% 1-2%	1/2 ① 2	Pale blue	Blackish brown	3		1
	4HP	Hydrogen sulphide	10-20% 0.5-10% 0.25-0.5%	1/2 ① 2	Pale blue	Blackish brown	3		

T: Temp Correction H: Humidity Correction +: Twin Tubes ++: Nine Tubes \* Refrigerated Storage Mesh: Correction Factor/Chart  
 ※2 Become "Yellow" under about 500 ppm. Become "Pale pink" over about 500 ppm. ※3 May become "Deep pink" at high concentration.  
 P: Use Pyrotec pyrolyzer No. 840 and GASTEC gas sampling pump.  
 See page 36 for additional symbols and definitions.

Gas or Vapour to be Measured Chemical Formula	Tube No. & Name		Measuring Range (ppm)	No. of Pump Strokes	Colour Change		Shelf Life (year)	Note	TLV-TWA, C (ACGIH) (ppm)
					Original	Stain			
Hydrogen sulphide H <sub>2</sub> S	4HH	Hydrogen sulphide	2-4% 0.1-2%	1/2 ①	Pale blue	Blackish brown	3		1
	4H	Hydrogen sulphide	2000-4000 100-2000 10-100	1/2 ① 2-10	White	Brown	3		
	4HM	Hydrogen sulphide	800-1600 50-800 25-50	1/2 ① 2	White	Brown	3		
	4M	Hydrogen sulphide	250-500 25-250 12.5-25	1/2 ① 2	White	Brown	3		
	4L	Hydrogen sulphide	120-240 10-120 1-10	1/2 ① 2-10	White	Brown	3		
	4LL	Hydrogen sulphide	60-120 2.5-60 0.25-2.5	1/2 ① 2-10	White	Brown	3		
	4LK	Hydrogen sulphide	20-40 2-20 1-2	1/2 ① 2	White	Brown	3		
	4LB	Hydrogen sulphide	6-12 1-6 0.5-1	1/2 ① 2	Yellow	Pink	2		
	4LT	Hydrogen sulphide	2.0-4.0 0.1-2.0 0.05-0.1	1/2 ① 2	Yellow	Pink	2*		
	45S	Hydrogen sulphide, Sulphur dioxide (Separate quantification)	H <sub>2</sub> S: 60-120 2.5-60 1.25-2.5	1/2 ① 2	White	Brown	3	+	
Hydrogen sulphide + Sulphur dioxide (Total Quantification) H <sub>2</sub> S+SO <sub>2</sub>	45H	Hydrogen sulphide + Sulphur dioxide	4.0-8.0% 0.2-4.0% 0.02-0.2%	1/2 ① 2-10	Brown	Pale yellow	3		H <sub>2</sub> S: 1
4-Hydroxy-4-methyl-2-pentanone	See Diacetone alcohol								
Iodine I <sub>2</sub>	9L	Nitrogen dioxide	0.2-12	2	White	Yellowish Orange	3		0.01
	80	Acid gases	0.12-2.4	2	Pale bluish purple	Light bluish gray	2		
Isoamyl acetate CH <sub>3</sub> CO <sub>2</sub> (CH <sub>2</sub> ) <sub>2</sub> CH(CH <sub>3</sub> ) <sub>2</sub>	148	Isoamyl acetate	10-200	2	Yellow	Pale blue	2	T	50
Isoamyl alcohol (CH <sub>3</sub> ) <sub>2</sub> CH(CH <sub>2</sub> ) <sub>2</sub> OH	117	Isoamyl alcohol	5-300	2	Yellow	Pale blue	3	T	100
Isobutane (CH <sub>3</sub> ) <sub>3</sub> CH	103	Hydrocarbons (Lower class)	0.84-1.68%	1/2	Yellowish brown	Greenish brown	2	++	
			0.07-0.84%	1					
			0.035-0.07%	2					
	104	Butane	55-3080	1	Orange	Dark green	3		
Isobutene (CH <sub>3</sub> ) <sub>2</sub> C:CH <sub>2</sub>	101L	Gasoline (Petrol)	0.07-2.2%	1	Orange	Dark green	3		250
Isobutyl acetate CH <sub>3</sub> CO <sub>2</sub> CH <sub>2</sub> CH(CH <sub>3</sub> ) <sub>2</sub>	144	Isobutyl acetate	10-300	2	Yellow	Blackish brown	2	T	150
Isobutyl acrylate CH <sub>2</sub> :CHCO <sub>2</sub> CH <sub>2</sub> CH(CH <sub>3</sub> ) <sub>2</sub>	142L	Butyl acetate	2.6-78	2	Yellow	Dark brown	2	T	
Isobutyl alcohol (CH <sub>3</sub> ) <sub>2</sub> CHCH <sub>2</sub> OH	116	Isobutyl alcohol	10-150	2	Yellow	Pale blue	3	T	50
Isooctane (CH <sub>3</sub> ) <sub>3</sub> CCH <sub>2</sub> CH(CH <sub>3</sub> ) <sub>2</sub>	101	Gasoline (Petrol)	0.027-0.54%	1	Orange	Dark green	3		300
Isopentane (CH <sub>3</sub> ) <sub>2</sub> CHCH <sub>2</sub> CH <sub>3</sub>	103	Hydrocarbons (Lower class)	1.08-2.16%	1/2	Yellowish brown	Greenish brown	2	++	1000
			0.09-1.08%	1					
			0.045-0.09%	2					
Isopentyl acetate	See Isoamyl acetate								

T: Temp Correction H: Humidity Correction +: Twin Tubes ++: Nine Tubes \* Refrigerated Storage Mesh: Correction Factor/Chart  
P: Use Pyrotec pyrolyzer No. 840 and GASTEC gas sampling pump.  
See page 36 for additional symbols and definitions.



Gas or Vapour to be Measured Chemical Formula	Tube No. & Name		Measuring Range (ppm)	No. of Pump Strokes	Colour Change		Shelf Life (year)	Note	TLV-TWA, C (ACGIH) (ppm)
					Original	Stain			
Isopentyl alcohol	See Isoamyl alcohol								
Isophorone C <sub>9</sub> H <sub>14</sub> O	154	Cyclohexanone	2-30	8	Pale yellow	Yellow	2*	T	C 5
Isopropyl acetate CH <sub>3</sub> CO <sub>2</sub> CH(CH <sub>3</sub> ) <sub>2</sub>	146	Isopropyl acetate	10-500	2	Yellow	Blackish brown	2	T	100
Isopropyl alcohol CH <sub>3</sub> CH(OH)CH <sub>3</sub> (i-C <sub>3</sub> H <sub>7</sub> OH)	113	Isopropyl alcohol	2.5-5.0% 0.04-2.5% 0.02-0.04%	1/2 ① 2	Pink	Pale blue	3	T	200
	113L	Isopropyl alcohol	50-800 20-50	① 2	Pink	Pale blue	3	T	
	113LL	Isopropyl alcohol	200-460 20-200	1 ②	Pink	Pale blue	2	T	
Isopropyl amine (CH <sub>3</sub> ) <sub>2</sub> CHNH <sub>2</sub>	180	Amines	5.5-110	1	Pink	Salmon pink	3	T	5
	180L	Amines	0.45-9	1	Pink	Pale orange	2	T	
Isopropyl ether [(CH <sub>3</sub> ) <sub>2</sub> CH] <sub>2</sub> O	141L	Ethyl acetate	18-720	2	Yellow	Blackish brown	2	T	250
	161	Ethyl ether	0.018-0.45%	2	Orange	Dark green	3	T	
Isopropyl mercaptane (CH <sub>3</sub> ) <sub>2</sub> CHSH	70	Mercaptans	10-240	1	White	Yellow	3	T	
Isovaleric acid (CH <sub>3</sub> ) <sub>2</sub> CHCH <sub>2</sub> CO <sub>2</sub> H	81	Acetic acid	2-50	1	Pink	Yellow	3	H	
	81L	Acetic acid	0.38-15	1	Pink	Pale yellow	2*	T	
LPG (Liquified petroleum gas)	100A	LPG	0.02-0.8%	1	Orange	Blackish green	3		
Maleic anhydride C <sub>4</sub> H <sub>2</sub> O <sub>3</sub>	81	Acetic acid	0.8-20	1	Pink	Yellow	3	H	0.01mg/m <sup>3</sup> (FV)
Mercaptans R-SH	70	Mercaptans	5-120 0.5-5	① 2-10	White	Yellow	3	T	
	70L	Mercaptans	4-8 0.5-4 0.2-0.5 0.1-0.2	1/2 ① 2 4	Yellow	Red	2		
2-Mercaptoethanol HSCH <sub>2</sub> CH <sub>2</sub> OH	75L	tert-Butyl mercaptan	0.5-7.5	1	Yellow	Pink	2*	T	
Mercury vapour Hg	40	Mercury vapour	6-13.2mg/m <sup>3</sup> 0.25-6mg/m <sup>3</sup> 0.05-0.25mg/m <sup>3</sup>	1/2 ① 5	White	Pale orange	3		0.025mg/m <sup>3</sup>
Mesityl oxide (CH <sub>3</sub> ) <sub>2</sub> C:CHCOCH <sub>3</sub>	141L	Ethyl acetate	27-1080	2	Yellow	Blackish brown	2	T	15
Methacrylic acid CH <sub>2</sub> :C(CH <sub>3</sub> )COOH	81	Acetic acid	1.8-45	1	Pink	Yellow	3	H	20
	81L	Acetic acid	0.35-14	1	Pink	Pale yellow	2*	T	
Methacrylonitrile CH <sub>2</sub> :C(CH <sub>3</sub> )CN	192	Methacrylonitrile	10-32	1	Yellow	Red	3	+	1
			0.5-10 0.2-0.5	② 4					
Methaldehyde (CH <sub>3</sub> CHO) <sub>n</sub>	91L	Formaldehyde	0.065-3.25	3	Yellow	Reddish brown	3*	T	
Methanethiol	See Methyl mercaptan								
Methanol CH <sub>3</sub> OH	111	Methanol	1.5-4.5% 0.02-1.5% 0.004-0.02% 0.002-0.004%	1/2 ① 2 4	Pink	Pale blue	3	T	200
	111L	Methanol	40-1000 20-40	① 2					
	111LL	Methanol	20-56 2-20	2 ④					
2-Methoxyethyl acetate CH <sub>3</sub> CO <sub>2</sub> CH <sub>2</sub> CH <sub>2</sub> OCH <sub>3</sub>	113L	Isopropyl alcohol	300-1300	2	Pink	Pale blue	3	T	0.1
1-Methoxy-2-propanol CH <sub>3</sub> OCH <sub>2</sub> CH(OH)CH <sub>3</sub>	113LL	Isopropyl alcohol	26-260	2	Pink	Pale blue	2	T	50

T: Temp Correction H: Humidity Correction +: Twin Tubes ++: Nine Tubes \* Refrigerated Storage Mesh: Correction Factor/Chart

P: Use Pyrotec pyrolyzer No. 840 and GASTEC gas sampling pump.

See page 36 for additional symbols and definitions.

Gas or Vapour to be Measured Chemical Formula	Tube No. & Name		Measuring Range (ppm)	No. of Pump Strokes	Colour Change		Shelf Life (year)	Note	TLV-TWA, C (ACGIH) (ppm)
					Original	Stain			
Methyl alcohol	See Methanol								
Methyl acrylate CH <sub>2</sub> :CHCO <sub>2</sub> CH <sub>3</sub>	141L	Ethyl acetate	8-320	2	Yellow	Blackish brown	2	T	2
2-Methyl allyl chloride CH <sub>2</sub> :C(CH <sub>3</sub> )CH <sub>2</sub> Cl	131La	Vinyl chloride	2.8-55	1	Yellow	Reddish brown	2*	+	
Methylamine CH <sub>3</sub> NH <sub>2</sub>	180	Amines	5-100	1	Pink	Pale brown/Yellow	3	T	5
	180L	Amines	0.5-10	1	Pink	Pale orange	2	T	
N-Methyl aniline C <sub>6</sub> H <sub>5</sub> NHCH <sub>3</sub>	181	Aniline	3.5-42	2	Pale yellow	Pale green	3		0.5
Methyl bromide CH <sub>3</sub> Br	136H	Methyl bromide	300-600	1/2	White	Yellow	3	+	1
			20-300	①					
			10-20	2					
	136L	Methyl bromide	100-200	1/2	White	Yellow	2	+	
			10-100	①					
			2.5-10	4					
	136LA	Methyl bromide	18-36	1	White	Yellow	2	+	
			1-18	②					
	136LL	Methyl bromide	1.2-3.0	1	White	Pale purple	2	+T	
			0.1-1.2	②					
2-Methyl-3-butenenitrile CH <sub>2</sub> :CHCH(CH <sub>3</sub> )CN	191L	Acrylonitrile	0.4-12	2	Yellow	Pink	3	+	
Methyl chloride CH <sub>3</sub> Cl	51	Fluorochlorocarbons (Pyrotec tube)	12-480	1	Yellow	Reddish purple	3	+P	50
	51L	Fluorochlorocarbons (Pyrotec tube)	32-86.4 1.6-32	1 2	Yellow	Reddish purple	3	+P	
Methyl chloroform	See 1,1,1-Trichloroethane								
Methyl chloroformate ClCO <sub>2</sub> CH <sub>3</sub>	131La	Vinyl chloride	58-1160	5	Yellow	Reddish brown	2*	+	
Methylcyclohexane C <sub>6</sub> H <sub>11</sub> CH <sub>3</sub>	102H	n-Hexane	0.04-0.84%	1	Orange	Dark green	3		400
Methylcyclohexanol CH <sub>3</sub> C <sub>6</sub> H <sub>10</sub> OH	119	Methylcyclohexanol	5-100	2	Yellow	Pale blue	2	T	50
Methylcyclohexanone C <sub>7</sub> H <sub>12</sub> O	155	Methylcyclohexanone	50-100 2-50	2 ③	Pale yellow	Yellow	2*	T	50
Methylene chloride CH <sub>2</sub> Cl <sub>2</sub>	138	Methylene chloride	50-500	①	White	Pale pink	3	+T	50
			20-50	2					
	138L	Methylene chloride	60-150	1	White	Pale pink	2	+T	
			10-60	②					
			4-10	4					
	51L	Fluorochlorocarbons (Pyrotec tube)	20-54 1-20	1 2	Yellow	Reddish purple	3	+P	
Methylene iodide CH <sub>2</sub> I <sub>2</sub>	121L	Benzene	0.22-22	5	White	Dark green	3	+	
Methyl ether CH <sub>3</sub> OCH <sub>3</sub>	161	Ethyl ether	0.03-0.85%	1	Orange	Dark green	3	T	
Methyl ethyl ketone CH <sub>3</sub> COC <sub>2</sub> H <sub>5</sub>	152	Methyl ethyl ketone	0.02-0.6%	2	Orange	Dark green	3	T	200
	152L	Methyl ethyl ketone	120-384	1/2	Yellow	Reddish purple	2*	+T	
			10-120	①					
151L	Acetone	21-1680	5	Yellow	Red	2*	T		

T: Temp Correction H: Humidity Correction +: Twin Tubes ++: Nine Tubes \* Refrigerated Storage Mesh: Correction Factor/Chart  
P: Use Pyrotec pyrolyzer No. 840 and GASTEC gas sampling pump.  
See page 36 for additional symbols and definitions.

Gas or Vapour to be Measured Chemical Formula	Tube No. & Name		Measuring Range (ppm)	No. of Pump Strokes	Colour Change		Shelf Life (year)	Note	TLV-TWA, C (ACGIH) (ppm)
					Original	Stain			
Methyl hydrazine H <sub>2</sub> NNHCH <sub>3</sub>	185	Hydrazine	0.6-12	5	Pink	Yellow	3	H	0.01
Methyl iodide CH <sub>3</sub> I	230H	Methyl iodide	15000-34800 6000-15000 100-6000	1/2 1 ②	White	Dark brown	2	T	2
	230	Methyl iodide	46-108 20-46 1-20 0.5-1	1/2 1 ② 4	White	Gray	2*	T	
	121L	Benzene	0.32-32	5	White	Dark green	3	+	
Methyl isobutyl ketone (CH <sub>3</sub> ) <sub>2</sub> CHCH <sub>2</sub> COCH <sub>3</sub>	153	Methyl isobutyl ketone	0.05-0.6%	2	Orange	Dark green	3	T	20
	153L	Methyl isobutyl ketone	50-130 2.5-50	1/2 ①	Pale yellow	Pale blue	1	T	
Methyl isothiocyanate CH <sub>3</sub> NCS	141L	Ethyl acetate	50-400	2	Yellow	Blackish brown	2	T	
Methyl mercaptan CH <sub>3</sub> SH	71H	Methyl mercaptan	1000-2700 50-1000 20-50	1/2 ① 2	White	Yellow	3		0.5
	71	Methyl mercaptan	70-140 2.5-70 0.25-2.5	1/2 ① 2-10	White	Yellow	3	T	
	70	Mercaptans	3.5-84 0.35-3.5	1 2-10	White	Yellow	3	T	
	70L	Mercaptans	4-8 0.5-4 0.2-0.5 0.1-0.2	1/2 1 2 4	Yellow	Red	2		
Methyl methacrylate CH <sub>2</sub> :C(CH <sub>3</sub> )CO <sub>2</sub> CH <sub>3</sub>	149	Methyl methacrylate	200-500 10-200	1 ②	Yellow	Pale blue	2	T	50
N-Methyl morpholine CH <sub>3</sub> N(C <sub>2</sub> H <sub>4</sub> ) <sub>2</sub> O	180	Amines	5-100	1	Pink	Yellow	3	T	
	180L	Amines	0.3-6	1	Pink	Pale orange	2	T	
4-Methyl pyridine C <sub>6</sub> H <sub>7</sub> N	182	Pyridine	0.38-10.5	1	Pink	Yellow	3	T	
N-Methyl pyrrolidone C <sub>5</sub> H <sub>9</sub> NO	180	Amines	13.5-270	1	Pink	White	3	T	
Monochlorobenzene	See Chlorobenzene								
Morpholine NH(C <sub>2</sub> H <sub>4</sub> )O	180	Amines	9-180	1	Pink	Yellow	3	T	20
	180L	Amines	0.5-10	1	Pink	Pale orange	2	T	
Naphthalene C <sub>10</sub> H <sub>8</sub>	60	Phenol	0.5-14	2	Pale yellow	Gray	2*	T	10
Nitric acid HNO <sub>3</sub>	15L	Nitric acid	20-40 1-20 0.1-1	1/2 ① 2-10	Yellow	Reddish Purple	3	H	2
	80	Acid gases	5-100	2	Pale bluish purple	Pale red purple	2		
Nitroethane CH <sub>3</sub> CH <sub>2</sub> NO <sub>2</sub>	52	Nitro compounds (Pyrotec tube)	4-240	1	White	Yellowish orange	3	P	100
Nitrogen dioxide NO <sub>2</sub>	9L	Nitrogen dioxide	30-125 0.5-30	1 ②	White	Yellowish orange	3		0.2
	10	NO & NO <sub>2</sub> (Separate quantification)	2.5-200	1	White	Yellowish orange	3	+	
	80	Acid gases	0.2-4	2	Pale bluish purple	Pinkish gray	2		

T: Temp Correction H: Humidity Correction +: Twin Tubes ++: Nine Tubes \* Refrigerated Storage Mesh: Correction Factor/Chart  
P: Use Pyrotec pyrolyzer No. 840 and GASTEC gas sampling pump.  
See page 36 for additional symbols and definitions.

Gas or Vapour to be Measured Chemical Formula	Tube No. & Name		Measuring Range (ppm)	No. of Pump Strokes	Colour Change		Shelf Life (year)	Note	TLV-TWA, C (ACGIH) (ppm)
					Original	Stain			
Nitrogen dioxide NO <sub>2</sub>	52	Nitrogen compounds (Pyrotec tube)	0.5-30	1	White	Yellowish orange	3	P	0.2
Nitrogen oxide NO	10	NO & NO <sub>2</sub> (Separate quantification)	5-200 2.5-5	① 2	White	Yellowish orange	3	+T	25
Nitrogen oxides NO+NO <sub>2</sub>	11HA	Nitrogen oxides (Total quantification)	50-2500	1	White	Green	2		NO : 25 NO <sub>2</sub> : 0.2
	11S	Nitrogen oxides (Total quantification)	250-625 10-250	1/2 ①	White	Pale green	2		
	11L	Nitrogen oxides (Total quantification)	5.0-16.5 0.2-5.0 0.08-0.2 0.04-0.08	1 ② 4 8	White	Yellowish orange	3		
Nitromethane CH <sub>3</sub> NO <sub>2</sub>	52	Nitro compounds (Pyrotec tube)	5-300	1	White	Yellowish orange	3	P	20
1-Nitropropane CH <sub>3</sub> CH <sub>2</sub> CH <sub>2</sub> NO <sub>2</sub>	52	Nitro compounds (Pyrotec tube)	4.2-252	1	White	Yellowish orange	3	P	25
2-Nitropropane (CH <sub>3</sub> ) <sub>2</sub> CHNO <sub>2</sub>	52	Nitro compounds (Pyrotec tube)	3.7-222	1	White	Yellowish orange	3	P	10
Nitrotrichloromethane	See Chloropicrin								
Nonane CH <sub>3</sub> (CH <sub>2</sub> ) <sub>7</sub> CH <sub>3</sub>	105	Hydrocarbons (Higher class)	260-3900 130-260	1 2	White	Blackish brown	3		200
Octane CH <sub>3</sub> (CH <sub>2</sub> ) <sub>6</sub> CH <sub>3</sub>	101	Gasoline (Petrol)	0.036-0.72%	1	Orange	Dark green	3		300
	105	Hydrocarbons(Higher class)	200-3000 100-200	1 2	White	Blackish brown	3		
Olefines	100A	LPG	0.34-13.6%	1	Orange	Blackish green	3		
Oxygen O <sub>2</sub>	31B	Oxygen	6-24% 3-6%	①② 1	Black	White	3	⊕	
Ozone O <sub>3</sub>	18M	Ozone	200-400 20-200 4-20	1/2 ① 2-5	Orange	Pale yellow	3		Heavy work:0.05 Moderate work:0.08 Light work:0.10 Heavy, moderate, or light workloads (≤2hours):0.20
	18L	Ozone	0.6-3 0.05-0.6 0.025-0.05	1 ⑤ 10	Blue	White	3		
Pentachloroethane Cl <sub>2</sub> CHCCl <sub>3</sub>	133L	Tetrachloroethylene	40-500	1	Yellow	Pink	2*	T	
1,3-Pentadiene CH <sub>3</sub> CH:CHCH:CH <sub>2</sub>	174	1,3-Butadiene	250-4000	1	Pale yellow	White	3	T	
	174L	1,3-Butadiene	42.5-850	4	Pale yellow	White	3		
Pentamethylenediamine H <sub>2</sub> N(CH <sub>2</sub> ) <sub>5</sub> NH <sub>2</sub>	180L	Amines	0.75-15	1	Pink	Grayish purple (Pale orange at the end of staining)*	2	T	
n-Pentane CH <sub>3</sub> (CH <sub>2</sub> ) <sub>3</sub> CH <sub>3</sub>	104	Butane	30-1680	1	Orange	Dark green	3		1000
	103	Hydrocarbons (Lower class)	0.9-1.8%	1/2	Yellowish brown	Greenish brown	2	++	
			0.075-0.9% 0.0375-0.075%	1 2					
2-Pentenenitrile CH <sub>3</sub> CH <sub>2</sub> CH:CHCN	193	2-Pentenenitrile	6-15 0.5-6	2 ④	Yellow	Red	3	+T	
	191L	Acrylonitrile	0.24-7.2	2	Yellow	Pink	3	+	
3-Pentenenitrile CH <sub>3</sub> CH:CHCH <sub>2</sub> CN	191L	Acrylonitrile	0.4-12	2	Yellow	Pink	3	+	

T: Temp Correction H: Humidity Correction +: Twin Tubes ++: Nine Tubes \* Refrigerated Storage Mesh: Correction Factor/Chart

⊕ Five tests (tubes) and long size glass detector tube for tube 31B only. P: Use Pyrotec pyrolyzer No. 840 and GASTEC gas sampling pump. ※1: Pale orange when low concentration

See page 36 for additional symbols and definitions.

Gas or Vapour to be Measured Chemical Formula	Tube No. & Name		Measuring Range (ppm)	No. of Pump Strokes	Colour Change		Shelf Life (year)	Note	TLV-TWA, C (ACGIH) (ppm)
					Original	Stain			
Pentyl acetate	See n-Amyl acetate								
Perchloroethylene	See Tetrachloroethylene								
Petroleum benzene	106	Petroleum naphtha	14-28mg/L 1-14mg/L 0.5-1mg/L	1/2 1 2	Orange	Dark Green	3		
Petroleum distillates	See Gasoline (Petrol)								
Petroleum ether	106	Petroleum naphtha	14-28mg/L 1-14mg/L 0.5-1mg/L	1/2 1 2	Orange	Dark Green	3		
Petroleum naphtha	106	Petroleum naphtha	14-28mg/L 1-14mg/L 0.5-1mg/L	1/2 ① 2	Orange	Dark green	3		
Phenol C <sub>6</sub> H <sub>5</sub> OH	60	Phenol	62.5-187 25-62.5 1-25 0.4-1	1/2 1 ② 4	Pale yellow	Gray	2*	T	5
Phenylethylene	See Styrene								
Phosgene COCl <sub>2</sub>	16	Phosgene	5-20 0.1-5 0.05-0.1	1 ⑤ 10	White	Yellow	1.5*	T	0.1
Phosphine PH <sub>3</sub>	7H	Phosphine	2500-5500 200-2500	1/2 ①	Yellow	Dark brown	2	T	0.3
	7J	Phosphine	500-1000 25-500 2.5-25	1/2 ① 2-10	White	Pale yellow	3		
	7	Phosphine	50-100 5-50 2.5-5	1 ② 4	White	Pale yellow	3		
	7L	Phosphine	0.3-5 0.15-0.3	⑤ 10	Pale yellow	Purple	3		
	7LA	Phosphine	2.5-9.8 1.5-2.5 0.1-1.5 0.05-0.1	1 3 ⑤ 10	Yellow	Red	2		
α-Pinene C <sub>10</sub> H <sub>16</sub>	121	Benzene	95-1140	3	White	Dark green	3		20
Propane CH <sub>3</sub> CH <sub>2</sub> CH <sub>3</sub>	103	Hydrocarbons(Lower class)	1.2-2.4% 0.1-1.2% 0.05-0.1%	1/2 1 2	Yellowish brown	Greenish brown	2	++	
Propionaldehyde CH <sub>3</sub> CH <sub>2</sub> CHO	91L	Formaldehyde	0.76-38	1	Yellow	Reddish brown	3*	T	20
	151L	Acetone	24-1880	2	Yellow	Red	2*	T	
Propionic acid CH <sub>3</sub> CH <sub>2</sub> COOH	81	Acetic acid	3-75	1	Pink	Yellow	3	H	10
	81L	Acetic acid	0.25-10	1	Pink	Pale yellow	2*	T	
Propionitrile CH <sub>3</sub> CH <sub>2</sub> CN	191	Acrylonitrile	50-1200	4	Yellow	Red	3	+T	
Propyl acetate CH <sub>3</sub> CO <sub>2</sub> CH <sub>2</sub> CH <sub>2</sub> CH <sub>3</sub>	145	Propyl acetate	20-500	2	Yellow	Blackish brown	2	T	200
Propyl alcohol CH <sub>3</sub> (CH <sub>2</sub> ) <sub>2</sub> OH	113	Isopropyl alcohol	0.04-2.5%	1	Pink	Pale blue	3	T	100
	113L	Isopropyl alcohol	130-560	1	Pink	Pale blue	3	T	
	113LL	Isopropyl alcohol	55-170	2	Pink	Pale blue	2	T	

T: Temp Correction H: Humidity Correction +: Twin Tubes ++: Nine Tubes \* Refrigerated Storage Mesh: Correction Factor/Chart  
P: Use Pyrotec pyrolyzer No. 840 and GASTEC gas sampling pump.  
See page 36 for additional symbols and definitions.

Gas or Vapour to be Measured Chemical Formula	Tube No. & Name		Measuring Range (ppm)	No. of Pump Strokes	Colour Change		Shelf Life (year)	Note	TLV-TWA, C (ACGIH) (ppm)
					Original	Stain			
Propylamine CH <sub>3</sub> (CH <sub>2</sub> ) <sub>2</sub> NH <sub>2</sub>	180	Amines	6-120	1	Pink	Salmon pink	3	T	
	180L	Amines	0.5-10	1	Pink	Pale orange	2	T	
n-Propyl bromide CH <sub>3</sub> (CH <sub>2</sub> ) <sub>2</sub> Br	136LA	Methyl bromide	1-18	2	White	Yellow	2	+	0.1
Propylene CH <sub>3</sub> CH:CH <sub>2</sub>	100A	LPG	0.02-0.8%	1	Orange	Blackish green	3		500
Propylene dichloride CH <sub>3</sub> CHClCH <sub>2</sub> Cl	131La	Vinyl chloride	40-800	2	Yellow	Reddish brown	2*	+	10
Propylene imine CH <sub>3</sub> CHCH <sub>2</sub> NH	180	Amines	5.5-110	1	Pink	Yellow	3	T	0.2
	180L	Amines	0.35-7	1	Pink	Pale orange	2	T	
Propylene oxide CH <sub>3</sub> CHCH <sub>2</sub> O	163	Ethylene oxide	0.065-3.9%	1	Orange	Green	3		2
	163L	Ethylene oxide	1-100	1	Yellow	Reddish brown	1*	+T	
Propyl mercaptan CH <sub>3</sub> (CH <sub>2</sub> ) <sub>2</sub> SH	70	Mercaptans	22.5-540	1	White	Yellow	3	T	
	70L	Mercaptans	4.8-9.6	1/2	Yellow	Red	2		
			0.6-4.8	1					
			0.24-0.6	2					
			0.12-0.24	4					
Pyridine C <sub>5</sub> H <sub>5</sub> N	182	Pyridine	14-35	1/2	Pink	Yellow	3	T	1
			0.5-14	①					
			0.2-0.5	2					
Stoddard solvent	128	Stoddard solvent	50-8000mg/m <sup>3</sup>	1	White	Brown (ring)	3		100
Styrene C <sub>6</sub> H <sub>5</sub> CH:CH <sub>2</sub>	124	Styrene	500-1500	1/2	White	Yellow	3		20
			20-500	①					
			10-20	2					
	124L	Styrene	25-100	1	White	Yellow	3		
			2-25	④					
	153	Methyl isobutyl ketone	0.075-0.9%	1	Orange	Dark green	3	T	
Sulphur dioxide SO <sub>2</sub>	5H	Sulphur dioxide	4-8%	1/2	Orange	Green	3		
			0.5-4%	①					
			0.05-0.5%	2-10					
	5M	Sulphur dioxide	1800-3600	1/2	Purple	Yellow	3	T	
			100-1800	①					
			20-100	4					
	5L	Sulphur dioxide	100-200	1/2	Blue	Yellow	3		
			5-100	①					
			2.5-5	2					
			1.25-2.5	4					
	5La	Sulphur dioxide	30-60	1	Blue	Yellow	3		
			2-30	②					
			1-2	4					
			0.5-1	8					
	5LC	Sulphur dioxide	10-25	1	Bluish purple	White	3	T	
			0.25-10	②					
			0.1-0.25	4					
	5Lb	Sulphur dioxide	5-10	1	Yellowish green	Yellow	3		
			0.2-5	②					
			0.1-0.2	4					
			0.05-0.1	8					
	45S	Hydrogen sulphide, sulphur dioxide (Separate quantification)	SO <sub>2</sub> : 10-20 0.5-10 0.25-0.5	1/2 ① 2	Yellowish green	Yellow	3	+	
	80	Acid gases	1.5-30	2	Pale bluish purple	Yellow	2		

T: Temp Correction H: Humidity Correction +: Twin Tubes ++: Nine Tubes \* Refrigerated Storage Mesh: Correction Factor/Chart

P: Use Pyrotec pyrolyzer No. 840 and GASTEC gas sampling pump.

See page 36 for additional symbols and definitions.

Gas or Vapour to be Measured Chemical Formula	Tube No. & Name		Measuring Range (ppm)	No. of Pump Strokes	Colour Change		Shelf Life (year)	Note	TLV-TWA, C (ACGIH) (ppm)
					Original	Stain			
Sulphur dioxide +Hydrogen sulphide (Total Quantification) SO <sub>2</sub> +H <sub>2</sub> S	45H	Hydrogen sulphide +Sulphur dioxide	4.0-8.0% 0.2-4.0% 0.02-0.2%	1/2 ① 2-10	Brown	Pale Yellow	3		
Sulphuric acid H <sub>2</sub> SO <sub>4</sub>	35	Sulphuric acid	0.5-5mg/m <sup>3</sup>	5	Pale yellow	Reddish purple	2	T	0.2mg/m <sup>3</sup>
Sulphuryl fluoride	See page 27								
1,1,2,2-Tetrabromoethane Br <sub>2</sub> CHCHBr <sub>2</sub>	135L	1,1,1-Trichloroethane (Methyl chloroform)	0.92-9.2	4	White	Pale Pink	2	+T	0.1
1,1,2,2-Tetrachloro-1,2-difluoroethane (R112) CCl <sub>2</sub> FCCL <sub>2</sub> F	51H	Fluorochlorocarbons (Pyrotec tube)	1000-3000 125-1000	1/2 1	White	Reddish orange	3	+P	50
	51	Fluorochlorocarbons (Pyrotec tube)	7-280	1	Yellow	Reddish purple	3	+P	
	51L	Fluorochlorocarbons (Pyrotec tube)	20-54 1-20	1 2	Yellow	Reddish purple	3	+P	
1,1,2,2-Tetrachloroethane Cl <sub>2</sub> CHCHCl <sub>2</sub>	131L	Vinyl chloride	2-30	2	Yellow	Reddish brown	2*	+T	1
Tetrachloroethylene Cl <sub>2</sub> C:CCl <sub>2</sub>	133HA	Tetrachloroethylene	300-900 20-300 7-20	1/2 ① 2	Yellow	Reddish purple	2*	T	25
	133M	Tetrachloroethylene	100-250 5-100 2-5	1/2 ① 2	Yellow	Reddish purple	2*	T	
	133L	Tetrachloroethylene	25-75 2-25 1-2	1/2 ① 2	Yellow	Pink	2*	T	
	133LL	Tetrachloroethylene	3-9 0.2-3 0.1-0.2	1/2 ① 2	Yellow	Purple	2*	T	
	132HH	Trichloroethylene	0.075-1.5%	1	White	Yellowish brown	3	T	
Tetrachloromethane	See Carbon tetrachloride								
Tetrahydrofuran C <sub>4</sub> H <sub>8</sub> O	159	Tetrahydrofuran	50-800 20-50	① 2	Pink	Pale blue	3	T	50
	159L	Tetrahydrofuran	80-232 5-80	1/2 ①	Pale yellow	Pale blue	1*	T	
	161	Ethyl ether	0.056-1.4%	1	Orange	Dark green	3	T	
Tetrahydrothiophene C <sub>4</sub> H <sub>8</sub> S	76H	Tetrahydrothiophene	10-200	1	Pink	Pale yellow	2	+T	
	76M	Tetrahydrothiophene	10-100mg/m <sup>3</sup>	2	Pink	Pale yellow	2	+T	
	76	Tetrahydrothiophene	1-10	4	Pink	Pale yellow	2	+T	
Tetramethylenediamine H <sub>2</sub> N(CH <sub>2</sub> ) <sub>4</sub> NH <sub>2</sub>	180	Amines	8.5-170	1	Pink	Purple to yellow	3	T	
	180L	Amines	0.8-16	1	Pink	Grayish purple (Pale orange at the end of staining)*	2	T	
Thionyle chloride SOCl <sub>2</sub>	5La	Sulphur dioxide	1.44-21.6	2	Blue	Yellow	3		C 0.2
Toluene C <sub>6</sub> H <sub>5</sub> CH <sub>3</sub>	122	Toluene	300-690 10-300 5-10	1/2 ① 2	White	Brown	3		20
	122L	Toluene	50-100 2-50 1-2	1 ② 4	White	Brown	3		
	161	Ethyl ether	0.02-0.8%	1	Orange	Dark green	3	T	

T: Temp Correction H: Humidity Correction +: Twin Tubes ++: Nine Tubes \* Refrigerated Storage Mesh: Correction Factor/Chart  
P: Use Pyrotec pyrolyzer No. 840 and GASTEC gas sampling pump. ※1: Pale orange when low concentration  
See page 36 for additional symbols and definitions.

Gas or Vapour to be Measured Chemical Formula	Tube No. & Name		Measuring Range (ppm)	No. of Pump Strokes	Colour Change		Shelf Life (year)	Note	TLV-TWA, C (ACGIH) (ppm)
					Original	Stain			
Toluol	See Toluene								
o-Toluidine C <sub>6</sub> H <sub>4</sub> (CH <sub>3</sub> )(NH <sub>2</sub> )	181	Aniline	5-60	2	Pale yellow	Pale green	3		2
Trichloroacetic acid CCl <sub>3</sub> COOH	15L	Nitric acid	1-37.5	1	Yellow	Reddish purple	3	H	0.5
1,2,4-Trichlorobenzene C <sub>6</sub> H <sub>3</sub> Cl <sub>3</sub>	131La	Vinyl chloride	0.65-13	4	Yellow	Reddish brown	2*	+	C 5
1,1,1-Trichloroethane (Methyl chloroform) CH <sub>3</sub> CCl <sub>3</sub>	135	1,1,1-Trichloroethane (Methyl chloroform)	500-2000 100-500	1/2 ①	White	Reddish orange	3	+T	350
	135L	1,1,1-Trichloroethane (Methyl chloroform)	200-900 20-200 6-20	1/2 ① 2	White	Pale pink	2	+T	
	171	Acetylene	0.06-1.2%	1	White	Brown	3	T	
1,1,2-Trichloroethane Cl <sub>2</sub> CHCH <sub>2</sub> Cl	135	1,1,1-Trichloroethane (Methyl chloroform)	220-750	2	White	Reddish orange	3	+T	10
Trichloroethylene Cl <sub>2</sub> C:CHCl	132HH	Trichloroethylene	1-2.5% 0.05-1%	1/2 ①	White	Yellowish brown	3	T	10
	132HA	Trichloroethylene	500-1300 50-500 20-50	1/2 ① 2	Yellow	Reddish purple	2*	T	
	132M	Trichloroethylene	100-250 5-100 2-5	1/2 ① 2	Yellow	Reddish purple	2*	T	
	132L	Trichloroethylene	25-70 2-25 1-2	1/2 ① 2	Yellow	Purple	2*	T	
	132LL	Trichloroethylene	4.0-8.8 0.25-4.0 0.125-0.25	1/2 ① 2	Yellow	Purple	2*	T	
Trichlorofluoromethane (R11) CCl <sub>3</sub> F	51H	Fluorochlorocarbons (Pyrotec tube)	2200-6600 275-2200	1/2 1	White	Reddish orange	3	+P	C 1000
	51	Fluorochlorocarbons (Pyrotec tube)	8-320	1	Yellow	Reddish purple	3	+P	
	51L	Fluorochlorocarbons (Pyrotec tube)	16-43.2 0.8-16	1 2	Yellow	Reddish purple	3	+P	
Trichloromethane	See Chloroform								
Trichloronitromethane	See Chloropicrin								
1,2,3-Trichloropropane CH <sub>2</sub> ClCHClCH <sub>2</sub> Cl	135L	1,1,1-Trichloroethane (Methyl chloroform)	36-360	4	White	Pale pink	2	+T	10
1,1,2-Trichloro-1,2,2-trifluoroethane (R113) CClF <sub>2</sub> CCl <sub>2</sub> F	51H	Fluorochlorocarbons (Pyrotec tube)	2000-6000 250-2000	1/2 ①	White	Reddish orange	3	+P	1000
	51	Fluorochlorocarbons (Pyrotec tube)	10-400	①	Yellow	Reddish purple	3	+P	
	51L	Fluorochlorocarbons (Pyrotec tube)	20-54 1-20	1 ②	Yellow	Reddish purple	3	+P	
1,1,1-Trichloro-2,2,2-trifluoroethane (R113a) CCl <sub>3</sub> CF <sub>3</sub>	51H	Fluorochlorocarbons (Pyrotec tube)	1600-4800 200-1600	1/2 1	White	Reddish orange	3	+P	
	51	Fluorochlorocarbons (Pyrotec tube)	10-400	1	Yellow	Reddish purple	3	+P	
	51L	Fluorochlorocarbons (Pyrotec tube)	16-43.2 0.8-16	1 2	Yellow	Reddish purple	3	+P	

T: Temp Correction H: Humidity Correction +: Twin Tubes ++: Nine Tubes \* Refrigerated Storage Mesh: Correction Factor/Chart  
P: Use Pyrotec pyrolyzer No. 840 and GASTEC gas sampling pump.  
See page 36 for additional symbols and definitions.



Gas or Vapour to be Measured Chemical Formula	Tube No. & Name		Measuring Range (ppm)	No. of Pump Strokes	Colour Change		Shelf Life (year)	Note	TLV-TWA, C (ACGIH) (ppm)
					Original	Stain			
Triethylamine (C <sub>2</sub> H <sub>5</sub> ) <sub>3</sub> N	180	Amines	4.5-90	1	Pink	Yellow	3	T	1
	180L	Amines	0.3-6	1	Pink	Pale orange	2	T	
Trimethylamine (CH <sub>3</sub> ) <sub>3</sub> N	3M	Ammonia	25-250	1	Purple	Yellow	3		5
	180	Amines	3.5-70	1	Pink	Yellow	3	T	
	180L	Amines	0.25-5	1	Pink	Pale orange	2	T	
Trimethyl benzene C <sub>6</sub> H <sub>3</sub> (CH <sub>3</sub> ) <sub>3</sub>	123	Xylene	10-300	2	White	Brown	3		25
Valeric acid CH <sub>3</sub> (CH <sub>2</sub> ) <sub>3</sub> COOH	81L	Acetic acid	0.38-15	1	Pink	Pale yellow	2*	T	
Vinyl acetate CH <sub>3</sub> CO <sub>2</sub> CH:CH <sub>2</sub>	143	Vinyl acetate	100-250	1	White	Brown	3	+	10
			10-100	②					
	141	Ethyl acetate	0.06-0.9%	1	Orange	Dark green	3	T	
Vinyl benzene	See Styrene								
Vinyl chloride CH <sub>2</sub> :CHCl	131	Vinyl chloride	1-2%	1/2	Orange	Dark green	3		1
			0.05-1%	①					
			0.025-0.05%	2					
	131La	Vinyl chloride	20-54	1/2	Yellow	Reddish brown	2*	+	
		1-20	①						
		0.5-1	2						
		0.25-0.5	4						
131L	Vinyl chloride	3-6.6	1	Yellow	Reddish brown	2*	+T		
		0.2-3	②						
		0.1-0.2	4						
131LB	Vinyl chloride	20-70	1	Yellow	Purple	2*	T		
		1-20	②						
		0.25-1	4						
Vinyl cyanide	See Acrylonitrile								
Vinylidene chloride CH <sub>2</sub> :CCl <sub>2</sub>	130L	Vinylidene chloride	14-40.6	1/2	Yellow	Reddish brown	2*	+	5
			1-14	①					
			0.4-1	2					
Vinyl trimethoxysilane CH <sub>2</sub> :CHSi(OCH <sub>3</sub> ) <sub>3</sub>	113L	Isopropyl alcohol	6.5-25.0	2	Pink	Pale blue	3	T	
Water vapour H <sub>2</sub> O	6	Water vapour	18-32mg/L	1/2	Yellowish green	Purple	3	T	
			1-18mg/L	①					
			0.5-1mg/L	2					
	6L	Water vapour	1-2mg/L	1/2	Yellow	Purple	3		
		0.05-1mg/L	①						
6LP	Pipeline Dew Point Tube	40-100LB/MMCF	1/2	Yellow	※4 Greenish purple	3	T		
		3-40LB/MMCF	①						
6LLP	Pipeline Dew Point Tube	2-10LB/MMCF	②	Yellow	Green	3	T		
Xylene C <sub>6</sub> H <sub>4</sub> (CH <sub>3</sub> ) <sub>2</sub>	123	Xylene	250-625	1/2	White	Brown	3		100
			10-250	①					
			5-10	2					
	123L	Xylene	100-200	1	White	Brown	3		
		2-100	②						
100A	LPG	0.1-1.2%	2	Orange	Blackish green	3			
122L	Toluene	100-200	1	White	Brown	3			
		4-100	2						
		2-4	4						

T: Temp Correction H: Humidity Correction +: Twin Tubes ++: Nine Tubes \* Refrigerated Storage Mesh: Correction Factor/Chart

LB / MMCF = Pound / Million Cubic Feet (1mg/L = 62.3LB / MMCF)

※4 May become "Purple" with high humidity. P: Use Pyrotec pyrolyzer No. 840 and GASTEC gas sampling pump.

See page 36 for additional symbols and definitions.

■ **Passive Dosi-tubes (Time Weighted Average Detector Tubes)**

Gas or Vapour to be Measured Chemical Formula	Tube No. & Name		Measuring Range (ppm)	Measuring Time (hours)	Colour Change		Shelf Life (year)	Note	TLV-TWA, C (ACGIH) (ppm)
					Original	Stain			
Acetaldehyde CH <sub>3</sub> CHO	91D	Formaldehyde	0.1-20	1-10	Yellow	Reddish brown	1*		C 25
	151D	Acetone	4-1200	1-10	Yellow	Reddish brown	2*	T	
	152D	Methyl ethyl ketone	1.2-360	1-10	Yellow	Reddish brown	2*	T	
Acetic acid CH <sub>3</sub> CO <sub>2</sub> H	81D	Acetic acid	0.5-100	1-10	Purple	Yellow	3	T	10
Acetic anhydride (CH <sub>3</sub> CO) <sub>2</sub> O	81D	Acetic acid	0.3-60	1-10	Purple	Yellow	3	T	1
Acetone CH <sub>3</sub> COCH <sub>3</sub>	151D	Acetone	5-1500	1-10	Yellow	Reddish brown	2*	T	500
	152D	Methyl ethyl ketone	1.4-420	1-10	Yellow	Reddish brown	2*	T	
Ammonia NH <sub>3</sub>	3D	Ammonia	2.5-1000	0.5-10	Purple	Yellow	3	T	25
	3DL	Ammonia	0.1-10	1-10	Pink	Yellow	2	TH	
Benzene C <sub>6</sub> H <sub>6</sub>	122DL	Toluene	2.4-600	1-10	white	Brown	2		0.5
1,3-Butadiene CH <sub>2</sub> :CH:CH:CH <sub>2</sub>	174D	1,3-Butadiene	1.3-200	1-8	Reddish purple	Pale brown	2	T	2
Carbon dioxide CO <sub>2</sub>	2D	Carbon dioxide	0.02-12%	0.5-10	Pale red	Yellow	2	T	5000
Carbon monoxide CO	1D	Carbon monoxide	1.04-2000	0.5-48	Pale yellow	Brown	2		25
	1DL	Carbon monoxide	0.4-400	0.5-24	Pale yellow	Brown	2*		
Chlorine Cl <sub>2</sub>	8D	Chlorine	0.08-100	0.5-24	White	Yellow	2		0.5
	132D	Trichloroethylene	2.4-240	1-8	Yellow	Purple	1*	T	
Cumene C <sub>6</sub> H <sub>5</sub> CH(CH <sub>3</sub> ) <sub>2</sub>	122DL	Toluene	3.4-850	1-10	White	Brown	2		50
1,2-Dichloroethylene ClCH:CHCl	174D	1,3-Butadiene	3.8-600	1-8	Reddish purple	Pale brown	2	T	200
	132D	Trichloroethylene	6-600	1-8	Yellow	Purple	1*	T	
Dimethylamine (CH <sub>3</sub> ) <sub>2</sub> NH	3D	Ammonia	1.9-750	0.5-10	Purple	Yellow	3	T	5
N,N-Dimethylethylamine C <sub>2</sub> H <sub>5</sub> N(CH <sub>3</sub> ) <sub>2</sub>	3D	Ammonia	4-1600	0.5-10	Purple	Yellow	3	T	
Ethanol C <sub>2</sub> H <sub>5</sub> OH	112D	Ethanol	100-25000	1-10	Yellow	Brown	3		
Ethyl benzene C <sub>6</sub> H <sub>5</sub> C <sub>2</sub> H <sub>5</sub>	122DL	Toluene	2.8-700	1-10	White	Brown	2		20
Ethylene CH <sub>2</sub> :CH <sub>2</sub>	174D	1,3-Butadiene	1.5-240	1-8	Reddish purple	Pale brown	2	T	200
Formaldehyde HCHO	91D	Formaldehyde	0.1-20	1-10	Yellow	Reddish brown	1*		C 0.3
Formic acid HCO <sub>2</sub> H	81D	Acetic acid	0.55-110	1-10	Purple	Yellow	3	T	5
Furfural C <sub>5</sub> H <sub>4</sub> O <sub>2</sub>	91D	Formaldehyde	0.3-60	1-10	Yellow	Reddish brown	1*		2
Hydrazine N <sub>2</sub> H <sub>4</sub>	3D	Ammonia	1.6-650	0.5-10	Purple	Yellow	3	T	0.01
Hydrogen chloride HCl	14D	Hydrogen chloride	1-100	1-10	Yellow	Purple	3	TH	C 2
	132D	Trichloroethylene	1.8-180	1-8	Yellow	Purple	1*	T	
Hydrogen cyanide HCN	12D	Hydrogen cyanide	1-200	1-10	Yellow	Pink	2		C 4.7
Hydrogen fluoride HF	14D	Hydrogen chloride	2.5-250	1-10	Yellow	Purple	3	TH	0.5
	17D	Hydrogen fluoride	1-100	1-10	Yellow	Purple	3	TH	
Hydrogen peroxide H <sub>2</sub> O <sub>2</sub>	32D	Hydrogen peroxide	0.5-40	1-10	White	Yellow	3	T	1

T: Temp Correction H: Humidity Correction \* Refrigerated Storage Mesh: Correction Factor/Chart  
See page 36 for additional symbols and definitions.

Gas or Vapour to be Measured Chemical Formula	Tube No. & Name		Measuring Range (ppm)	Measuring Time (hours)	Colour Change		Shelf Life (year)	Note	TLV-TWA, C (ACGIH) (ppm)
					Original	Stain			
Hydrogen sulphide H <sub>2</sub> S	4D	Hydrogen sulphide	0.2-200	1-48	White	Brown	3		1
Isoprene CH <sub>2</sub> :C(CH <sub>3</sub> )CH:CH <sub>2</sub>	174D	1,3-Butadiene	2.5-400	1-8	Reddish purple	Pale brown	2	T	
Methylamine CH <sub>3</sub> NH <sub>2</sub>	3DL	Ammonia	0.19-19	1-10	Pink	Yellow	2	TH	5
Methyl ethyl ketone CH <sub>3</sub> COC <sub>2</sub> H <sub>5</sub>	152D	Methyl ethyl ketone	2-600	1-10	Yellow	Reddish brown	2*	T	200
	91D	Formaldehyde	0.125-25	1-10	Yellow	Reddish brown	1*		
	151D	Acetone	6.5-1950	1-10	Yellow	Reddish brown	2*	T	
Methyl isobutyl ketone (CH <sub>3</sub> ) <sub>2</sub> CHCH <sub>2</sub> COCH <sub>3</sub>	151D	Acetone	11.5-3450	1-10	Yellow	Reddish brown	2*	T	20
	152D	Methyl ethyl ketone	4-1200	1-10	Yellow	Reddish brown	2*	T	
Nitric acid HNO <sub>3</sub>	14D	Hydrogen chloride	0.8-80	1-10	Yellow	Purple	3	TH	2
	17D	Hydrogen fluoride	0.32-32	1-10	Yellow	Purple	3	TH	
Nitrogen dioxide NO <sub>2</sub>	9D	Nitrogen dioxide	0.1-30	1-10	White	Yellow	1*	T	0.2
	9DL	Nitrogen dioxide	0.01-3.0	1-24	White	Green	1*		
Styrene C <sub>6</sub> H <sub>5</sub> CH:CH <sub>2</sub>	122DL	Toluene	26-6500	1-10	White	Brown	2		20
Sulphur dioxide SO <sub>2</sub>	5DH	Sulphur dioxide	10-600	1-5	Bluish purple	White	3	T	
	5D	Sulphur dioxide	0.2-100	1-10	Green	Yellow	3		
Tetrachloroethylene Cl <sub>2</sub> C:CCl <sub>2</sub>	133D	Tetrachloroethylene	3-150	1-8	Yellow	Purple	1*	T	25
	132D	Trichloroethylene	1.5-150	1-8	Yellow	Purple	1*	T	
Toluene C <sub>6</sub> H <sub>5</sub> CH <sub>3</sub>	122DL	Toluene	2-500	1-10	White	Brown	2		20
Trichloroethylene Cl <sub>2</sub> C:CHCl	132D	Trichloroethylene	3-300	1-8	Yellow	Purple	1*	T	10
Triethylamine (C <sub>2</sub> H <sub>5</sub> ) <sub>3</sub> N	3D	Ammonia	5.3-2100	0.5-10	Purple	Yellow	3	T	1
Trimethylamine (CH <sub>3</sub> ) <sub>3</sub> N	3DL	Ammonia	0.23-23	1-10	Pink	Yellow	2	TH	5
Vinyl chloride CH <sub>2</sub> :CHCl	174D	1,5-Butadiene	1.5-240	1-8	Reddish Purple	Pale brown	2	T	1
Xylene C <sub>6</sub> H <sub>4</sub> (CH <sub>3</sub> ) <sub>2</sub>	122DL	Toluene	3.4-850	1-10	White	Brown	2		100

T: Temp Correction H: Humidity Correction \* Refrigerated Storage Mesh: Correction Factor/Chart  
See page 36 for additional symbols and definitions.

### Measurement procedure

- Write down the starting time of measurement on an adhesive label included inside each box of Dosi-tubes, and place the label onto the tube.
- Insert the G marked end of the Dosi-tube into the No.710 Tube Holder, and break the tube end at the breaking line (A). Remove the broken end from the Tube holder.

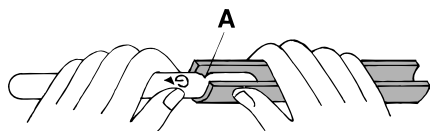

- Insert the Dosi-tube fully into the Tube holder.

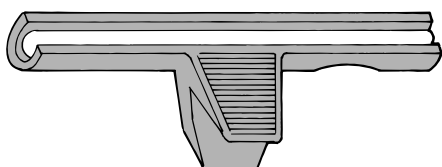

- Attach the Tube Holder with the Dositube to the shirt collar for personal sampling, or put it on an appropriate measurement point in the workplace for area monitoring.
- When the measurement is finished, write down the finishing time on the label, and determine the actual sampling time :  
= (finishing time) - (starting time)
- Obtain the average concentration (TWA value) by the following formula.

$$\text{TWA value (ppm)} = \frac{\text{Dosi-tube reading (ppm} \cdot \text{hr)}}{\text{Actual sampling time (hr)}}$$

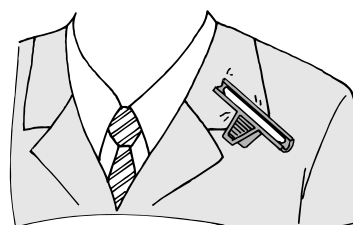

### ■ Sulphuryl fluoride measurement system

GASTEC developed the Pyrotec pyrolyzer system to enable precise and easy detection of Sulphuryl fluoride. It converts Sulphuryl fluoride (using a process known as thermal cracking) into an easily measurable gas.

\* Use Sulphuryl fluoride pyrotube No. 231, Pyrotec pyrolyzer No. 860, and GASTEC gas sampling pump.

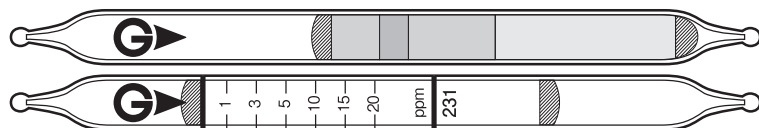

Gas or Vapour to be Measured Chemical Formula	Tube No. & Name		Measuring Range (ppm)	No. of Pump Strokes	Colour Change		Shelf Life (year)	Note
					Original	Stain		
Sulphuryl fluoride SO <sub>2</sub> F <sub>2</sub>	231	Sulphuryl fluoride	1-20	3	Bluish purple	White	2	+T ※5

T: Temp Correction +: Twin Tubes ※5 for four test

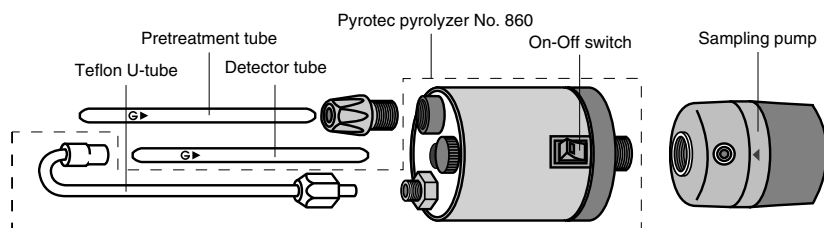

### ■ 30m Extension hose No.351A-30

The extension hose can be attached to the tip of the gas sampling pump and used for remote downward (30m) measurement.

\* When merely the extension hose tip needs to be replaced or for twin tube operation, simply order the Extension Hose guard rubber (No.358) only.

Currently only the detector tubes listed below are applicable to No. 351A-30. If you need to use other tube, please contact your Gastec representatives.

Gas or Vapour to be Measured	Chemical Formula	Tube No. & Name		Measuring Range (ppm)	Shelf Life (year)	Note
Acetaldehyde	CH <sub>3</sub> CHO	92M	Acetaldehyde	2.5—100	2*	F
Acetic acid	CH <sub>3</sub> CO <sub>2</sub> H	81L	Acetic acid	0.125—25.0	2*	TF
Acetone	CH <sub>3</sub> COCH <sub>3</sub>	151L	Acetone	50—12000	2*	T
Acrylonitrile	CH <sub>2</sub> :CHCN	191L	Acrylonitrile	0.1—18	3	+
Ammonia	NH <sub>3</sub>	3M	Ammonia	10—1000	3	
		3La	Ammonia	2.5—200	3	T
		3L	Ammonia	0.5—78	3	TF
Aromatic hydrocarbons		120	Aromatic hydrocarbons	0.4—200	3	F
Arsine	AsH <sub>3</sub>	19La	Arsine	0.04—10	2	
Benzene	C <sub>6</sub> H <sub>6</sub>	121S	Benzene	2—312	3	+F
		121	Benzene	2.5—120	3	F
		121SL	Benzene	1—100	3	+F
		121L	Benzene	0.1—65	3	+F
1,3-Butadiene	CH <sub>2</sub> :CHCH:CH <sub>2</sub>	174	1,3-Butadiene	50—800	3	T
		174L	1,3-Butadiene	2.5—100	3	
Carbon dioxide	CO <sub>2</sub>	2HH	Carbon dioxide	2.5—40%	3	F
		2H	Carbon dioxide	0.5—20%	3	F
		2L	Carbon dioxide	0.13—6%	3	
		2LL	Carbon dioxide	300—5000	3	
		2LC	Carbon dioxide	100—4000	2	
Carbon monoxide	CO	1L	Carbon monoxide	2.5—2000	3	F
		1LK	Carbon monoxide	5—600	3	
		1LL	Carbon monoxide	5—50	3	F
Chloropicrin	Cl <sub>3</sub> CNO <sub>2</sub>	134	Carbon tetrachloride	2.5—60	1*	+F
		134L	Carbon tetrachloride	0.125—2.5	1*	+F
Cyclohexanol	C <sub>6</sub> H <sub>11</sub> OH	118	Cyclohexanol	5—100	2	TF
1,2-Dichloroethylene	CICH:CHCl	139	1,2-Dichloroethylene	5—250	2*	T
1,3-Dichloropropene	CICH <sub>2</sub> CH:CHCl	131La	Vinyl chloride	0.5—10	2*	+F
Dichlorvos	C <sub>4</sub> H <sub>7</sub> Cl <sub>2</sub> O <sub>4</sub> P	132LL	Trichloroethylene	0.11—1.8	2*	TF
Ethanol	C <sub>2</sub> H <sub>5</sub> OH	112	Ethanol	0.01—7.5%	3	TF
		112L	Ethanol	50—2000	3	TF
Ethyl acetate	CH <sub>3</sub> CO <sub>2</sub> C <sub>2</sub> H <sub>5</sub>	141L	Ethyl acetate	20—800	2	T
Ethylene	CH <sub>2</sub> :CH <sub>2</sub>	172	Ethylene	25—1680	3	TF
		172L	Ethylene	0.2—100	3	TF
Ethylene glycol	HOCH <sub>2</sub> CH <sub>2</sub> OH	165L	Ethylene glycol	10—100mg/m <sup>3</sup>	3*	+TF
Ethyl mercaptan	C <sub>2</sub> H <sub>5</sub> SH	72	Ethyl mercaptan	0.5—120	3	TF

T: Temp Correction H: Humidity Correction +: Twin Tubes ++: Nine Tubes \* Refrigerated Storage

F: Correction factors might be applied when using No. 351A-30. See No. 351A-30 instruction manual for details. Measuring ranges above will be changed in case correction factors are applied.

Gas or Vapour to be Measured	Chemical Formula	Tube No. & Name		Measuring Range (ppm)	Shelf Life (year)	Note
Ethylene oxide	C <sub>2</sub> H <sub>4</sub> O	163	Ethylene oxide	0.05 – 3.0%	3	F
		163L	Ethylene oxide	0.4 – 350	1*	+TF
		163LL	Ethylene oxide	0.1 – 10	1*	+TF
Ethyl ether	(C <sub>2</sub> H <sub>5</sub> ) <sub>2</sub> O	161	Ethyl ether	0.04 – 1%	3	TF
Formaldehyde	HCHO	91L	Formaldehyde	0.1 – 40.0	3*	TF
Gasoline	C <sub>n</sub> H <sub>m</sub>	101L	Gasoline	30 – 2000	3	F
Hexane	CH <sub>3</sub> (CH <sub>2</sub> ) <sub>4</sub> CH <sub>3</sub>	102L	Hexane	4 – 1200	3	F
Hydrocarbons(Higher class)		105	Hydrocarbons(Higher class)	100 – 3000	3	
Hydrocarbons (Lower class)		103	Hydrocarbons (Lower class)	0.05 – 2.4%	2	++
Hydrogen	H <sub>2</sub>	30	Hydrogen	0.5 – 2%	3	
Hydrogen sulphide	H <sub>2</sub> S	4HH	Hydrogen sulphide	0.1 – 4%	3	
		4H	Hydrogen sulphide	10 – 4000	3	
		4HM	Hydrogen sulphide	25 – 1600	3	
		4M	Hydrogen sulphide	12.5 – 500	3	
		4L	Hydrogen sulphide	1 – 240	3	
		4LL	Hydrogen sulphide	0.25 – 120	3	
		4LK	Hydrogen sulphide	1 – 40	3	
		4LB	Hydrogen sulphide	0.5 – 12	2	
4LT	Hydrogen sulphide	0.05 – 4.0	2*			
Isoamyl alcohol	(CH <sub>3</sub> ) <sub>2</sub> CH(CH <sub>2</sub> ) <sub>2</sub> OH	117	Isoamyl alcohol	5 – 300	3	TF
LPG		100A	LPG	0.02 – 0.8%	3	
Mercaptans	R · SH	70	Mercaptans	0.5 – 120	3	T
		70L	Mercaptans	0.1 – 8	2	
Mercury vapour	Hg	40	Mercury vapour	0.05 – 13.2mg/m <sup>3</sup>	3	F
Methanol	CH <sub>3</sub> OH	111	Methanol	0.002 – 4.5%	3	TF
		111L	Methanol	20 – 1000	3	TF
Methyl bromide	CH <sub>3</sub> Br	136H	Methyl bromide	10 – 600	3	+
		136L	Methyl bromide	2.5 – 200	2	+
		136LA	Methyl bromide	1 – 36	2	+F
		136LL	Methyl bromide	0.1 – 3.0	2	+T
Methyl iodide	CH <sub>3</sub> I	230H	Methyl iodide	100 – 34800	2	TF
		230	Methyl iodide	0.5 – 108	2*	TF
Methyl isothiocyanate	CH <sub>3</sub> NCS	141L	Ethyl acetate	50 – 400	2	TF
Nitric acid	HNO <sub>3</sub>	15L	Nitric acid	0.1 – 40	3	HF
Nitrogen dioxide	NO <sub>2</sub>	9L	Nitrogen dioxide	0.5 – 125	3	F
Nitrogen oxides	NO+NO <sub>2</sub>	11L	Nitrogen oxides	0.04 – 16.5	3	F
Petroleum naphtha		106	Petroleum naphtha	0.5 – 28mg/L	3	
Phenol	C <sub>6</sub> H <sub>5</sub> OH	60	Phenol	0.4 – 187	2*	TF
Phosphine	PH <sub>3</sub>	7H	Phosphine	200 – 5500	2	T
		7J	Phosphine	2.5 – 1000	3	F
		7	Phosphine	2.5 – 100	3	
		7L	Phosphine	0.15 – 5	3	
		7LA	Phosphine	0.05 – 9.8	2	
Styrene	C <sub>6</sub> H <sub>5</sub> CH:CH <sub>2</sub>	124	Styrene	10 – 1500	3	F
		124L	Styrene	2 – 100	3	F
Sulphur dioxide	SO <sub>2</sub>	5La	Sulphur dioxide	0.5 – 60	3	
		5Lb	Sulphur dioxide	0.05 – 10.0	3	F
		5Lc	Sulphur dioxide	0.1 – 25	3	T
Sulphuric acid	H <sub>2</sub> SO <sub>4</sub>	35	Sulphuric acid	0.5 – 5mg/m <sup>3</sup>	2	T
Sulphuryl fluoride	SO <sub>2</sub> F <sub>2</sub>	231	Sulphuryl fluoride	1 – 20	2	+T ※6
Toluene	C <sub>6</sub> H <sub>5</sub> CH <sub>3</sub>	122	Toluene	5 – 690	3	F
		122L	Toluene	1 – 100	3	F
1,1,1-Trichloroethane	CH <sub>3</sub> CCl <sub>3</sub>	135	1,1,1-Trichloroethane	100 – 2000	3	+T
Vinyl chloride	CH <sub>2</sub> :CHCl	131	Vinyl chloride	0.025 – 2.0%	3	F
		131La	Vinyl chloride	0.25 – 54	2*	+
		131LB	Vinyl chloride	0.25 – 70	2*	TF
		131L	Vinyl chloride	0.1 – 6.6	2*	+TF
Water vapour	H <sub>2</sub> O	6L	Water vapour	0.05 – 2.0mg/L	3	
Xylene	C <sub>6</sub> H <sub>4</sub> (CH <sub>3</sub> ) <sub>2</sub>	123	Xylene	5 – 625	3	F
		123L	Xylene	2 – 200	3	F

T: Temp Correction H: Humidity Correction +: Twin Tubes ++: Nine Tubes \* Refrigerated Storage ※6: for four test

F: Correction factors might be applied when using No. 351A-30. See No. 351A-30 instruction manual for details.

Measuring ranges above will be changed in case correction factors are applied.

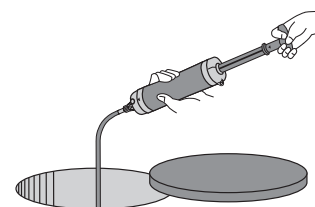

**Qualitative analysis system for inorganic/organic gas qualitative detector tubes**

Gas or Vapour to be Measured	Tube No. & Name		Measuring Range (ppm)	No. of Pump Strokes	Colour Change		Shelf Life (year)
					Original	Stain	
NH <sub>3</sub> , SO <sub>2</sub> , H <sub>2</sub> S, CO, NO <sub>2</sub> , R.SH	25	Polytec tube-II	Qualitative analysis	1	Qualitative analysis		2
NH <sub>3</sub> , H <sub>2</sub> S, CnHm	26	Polytec tube-III	Qualitative analysis	1	Qualitative analysis		2
NH <sub>3</sub> , HCl, H <sub>2</sub> S, SO <sub>2</sub> , NO <sub>2</sub> , CO, CO <sub>2</sub>	27	Polytec tube-IV	Qualitative analysis	1	Qualitative analysis		1.5
HCl, COCl <sub>2</sub> , SO <sub>2</sub> , NO <sub>2</sub> , H <sub>2</sub> S, HCN, CO, CO <sub>2</sub>	28	Polytec tube-V	Qualitative analysis	1	Qualitative analysis		1.5
Unknown Gases	107	Polytec tube-I	Qualitative analysis	3	Qualitative analysis		3
Kerosene, Gasoline	108	Qualitative analysis tube for fire investigation	Qualitative analysis	1	Qualitative analysis		3

The Gastec polytec system consists of the Model GV-100S Gas sampling pump and the Polytec tubes. The Polytec tubes are unique detector tubes, each having 1 to 8 reaction layers to determine multiple unknown substances in the sample simultaneously. When you pull the handle of the Pump and wait for a predetermined sampling time, the colour (s) of the Polytec tube's layer (s) change uniquely according to the contents of the sample. Six types of Polytec tubes are available: Polytec I (No.107), Polytec II (No.25), Polytec III (No.26), Polytec IV (No.27), Polytec V (No.28), and Qualitative analysis tube for fire investigation (No.108). Detailed descriptions are given in the instruction sheets included with individual Polytec tubes. If you already have the Model GV-100S gas sampling pump, you need only to obtain the desired Polytec tubes.

**Polytec I (No. 107)**

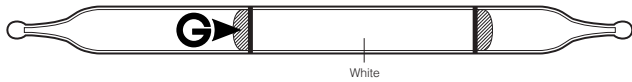

**Qualitative analysis tube for fire investigation (No. 108)**

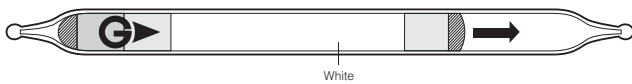

**Polytec II (No. 25)**

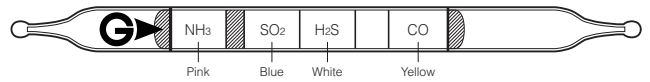

**Polytec III (No. 26)**

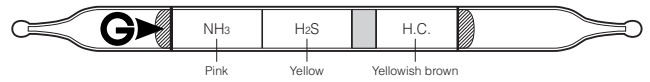

**Polytec IV (No. 27)**

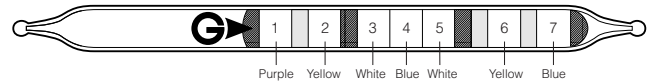

**Polytec V (No. 28)**

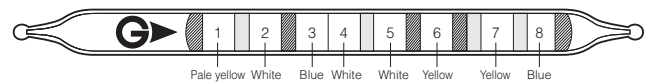

**Example :**

**Polytec V (No. 28)**

Detecting layer	1	2	3	4	5	6	7	8
Original colour	Pale yellow	White	Blue	White	White	Yellow	Yellow	Blue
Colour change	Red	Yellow	Yellow	Yellow	Brown	Pink	Blackish brown, Gray, Yellowish orange	Brown
Substance	Hydrogen chloride	Phosgene, Chlorine, Nitrogen dioxide	Sulphur dioxide	Nitrogen dioxide	Hydrogen sulphide	Hydrogen sulphide, Hydrogen cyanide, Hydrogen phosphide	Carbon monoxide, Hydrogen, Hydrogen phosphide, Acetylene, Ethylene, Propylene, Methyl mercaptan	Carbon dioxide

**Polytec IV (No. 27)**

Detecting layer	1	2	3	4	5	6	7
Original colour	Purple	Yellow	White	Blue	White	Yellow	Blue
Colour change	Yellow	Red	Brown	Yellow, Purple	Yellow, Yellowish orange	Blackish brown, Gray, Yellowish orange	Brown
Substance	Ammonia, Diethylamine	Hydrogen chloride	Hydrogen sulphide	Chlorine, Sulphur dioxide, Nitrogen dioxide	Chlorine, Nitrogen dioxide	Hydrogen sulphide, Carbon monoxide, Hydrogen, Phosphine, Acetylene, Ethylene, Propylene, Methyl mercaptan	Carbon dioxide

## Injection method detector tubes

Gas or Vapour to be Measured	Chemical Formula	Tube No. & Name		Measuring Range (ppm)	Sampling Volume	Colour Change		Shelf Life (year)
						Original	Stain	
Carbon dioxide	CO <sub>2</sub>	2HT	Carbon dioxide	10-100%	20mL/20sec.	White	Purple	3
Propane	CH <sub>3</sub> CH <sub>2</sub> CH <sub>3</sub>	100B	Propane	0.1-2%	20mL/120sec.	Brown	Blackish green	3

① Attach the syringe inlet to the syringe (No.601 or No.611) and collect 20ml of sample into the syringe by pulling its piston.

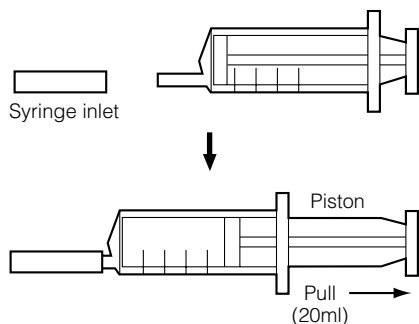

③ Insert the tube securely into the syringe inlet with the arrow pointing away from the syringe. Inject the sample collected in the syringe into the detector tube in 2 minutes (for No.100B) or 20 seconds (for No.2HT), and read the indication.

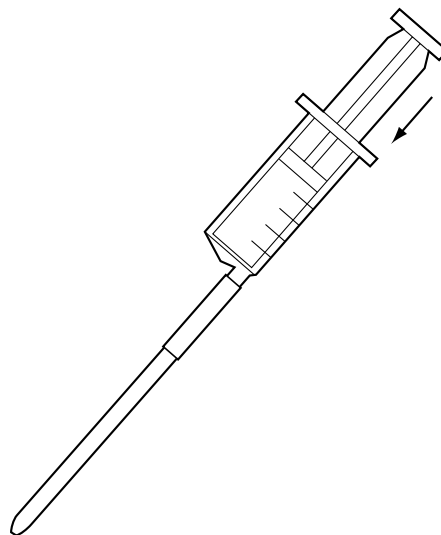

② Break off both ends of a detector tube (No.100B for No.601 syringe or No.2HT for No.611 syringe) by using the tube tip breaker.

## Detector tubes for dissolved substances in solution

Substance to be Measured	Chemical Formula	Tube No. & Name		Measuring Range (ppm)	Sampling Method	Colour Change		Shelf Life (year)
						Original	Stain	
Sulphide ion in solution	S <sup>2-</sup>	211H	Sulphide ion tube	10-1000	Immersion	White	Brown	3
		211M	Sulphide ion tube	2-300	Immersion	White	Brown	3
		211	Sulphide ion tube	1-100	Immersion	White	Brown	3
		211LL	Sulphide ion tube	0.5-20	Immersion	White	Brown	3
Ozone in solution	O <sub>3</sub>	218	Ozone tube	1-10mg/L	Immersion	Pale blue	White	3
Bromide ion in solution	Br <sup>-</sup>	221L	Chloride ion tube	55-2200mg/L	Immersion	Brown	White	3
		221LL	Chloride ion tube	24-480mg/L	Immersion	Brown	White	3
Chloride ion in solution	Cl <sup>-</sup>	221L	Chloride ion tube	25-1000mg/L	Immersion	Brown	White	3
		221LL	Chloride ion tube	10-200mg/L	Immersion	Brown	White	3
Free residual chlorine	ClO <sup>-</sup>	222	Free residual chlorine tube	0.1-10mg/L	Immersion	White	Reddish orange	2
Mercury in solution	Hg	271	Mercury tube	1-20mg/L	Immersion	Pale orange	Bluish purple	3
Chromium(VI)ion in solution	Cr <sup>6+</sup>	273	Chromium(VI)ion tube	0.5-50mg/L	Immersion	White	Yellow	3
Iron ion in solution	Fe <sup>2+</sup>	281	Iron ion tube	5-50mg/L	Immersion	White	Orange	3
Copper ion in solution	Cu <sup>2+</sup>	284	Copper ion tube	1-20mg/L	Immersion	White	Orange	2*
Zinc in solution	Zn	285	Zinc tube	3-20mg/L	Immersion	Pale orange	Reddish purple	3
Nickel in solution	Ni	291	Nickel tube	5-50mg/L	Immersion	White	Red	3

Dissolved substance in solution can be measured by simply immersing the above Gastec tube into a solution. When the detector tube is immersed vertically into (▶) Pointing upward, the solution will rise up through the tube due to capillary action and react with reagent in the tube.

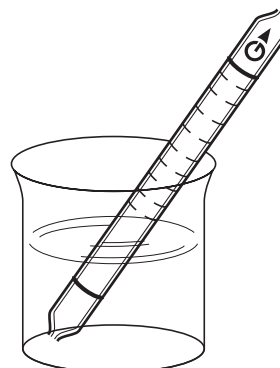

■ **Airtec tube - Compressed breathing air detector tubes**

Gas or Vapour to be Measured	Chemical Formula	Tube No. & Name		Measuring Range (ppm)	Flow Rate (mL/min)	Sampling Time (min)	Colour Change		Shelf Life (year)
							Original	Stain	
Carbon monoxide	CO	1A	Carbon monoxide Airtec tube	5-50	100	3	Yellow	Dark brown	2
Carbon dioxide	CO <sub>2</sub>	2A	Carbon dioxide Airtec tube	250-3000	100	5	Orange yellow	Yellow	2
		2Ag	Carbon dioxide Airtec tube	200-3000	100	1.5	Pale blue	Purple	3
Water vapour	H <sub>2</sub> O	6AH	Water vapour Airtec tube	500-5000	300	1	Green	Purple	2
		6A	Water vapour Airtec tube	20-80mg/m <sup>3</sup>	100	5	Yellow	Green	2
		6Ag	Water vapour Airtec tube	150-3000mg/m <sup>3</sup>	300	1	Green	Purple	2
Nitrogen oxides	NO+NO <sub>2</sub>	11A	Nitrogen oxides Airtec tube	0.06-2	100	2	white	Bluish green	3
				0.02-0.7	100	5			
Oil mist		109AD	Oil mist Airtec tube	0.2-5.0mg/m <sup>3</sup>	1000	20	Pale red	Pale blue	2
		109A	Oil mist Airtec tube	0.3-1.5mg/m <sup>3</sup>	1000	60	White	Dark green	2

Gastec Airtec Tube allows anyone to simply, quickly, and quantitatively measure the quality of their compressed breathing air. Easy to use, the Airtec tube is an accurate and precise method for detecting CO, CO<sub>2</sub>, Water vapour, Nitrogen oxides and Oil mist. Using Airtec tube direct reading vapour tubes, simply connect the pressure reducer to your high pressure air source, compressor, cylinder, or air line and adjust the flowmetre to the required setting.

Operators often produce or are performed in the presence of harmful airborne contaminants. When self-contained breathing apparatus or other devices are used for respiratory protection, the quality of the breathing air requires special attention. Contaminants entering the compressor or contaminants generated by the compressor can be harmful to the worker and the respiratory equipment.

Airtec tube is a convenient economical system for testing the quality of your compressed breathing air. You do not have to learn how to operate and calibrate sophisticated instrumentation. With Airtec Tube, the measurement is quick and simple and does not require user calibration. Just snap off both "break away" ends of the tube, insert the tube into the tube holder with the directional arrow pointing down, and adjust the flowmetre to the specified flow rate. After the required time, note where the colour stain stops and take the measurement from the direct reading tube.

■ **Measurement procedure: (a case of contaminant test in cylinder)**

1. Install a pressure reducer with gauge and flowmetre to a cylinder, compressor or air line and adjust the flowmetre the required setting.

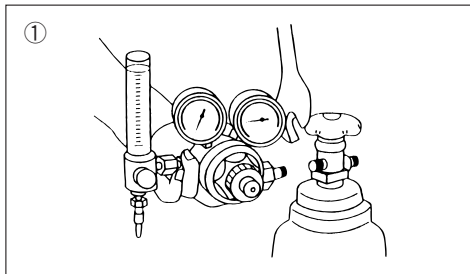

2. Break tips off a fresh detector tube in the tube tip breaker and insert a tube into a tube holder.

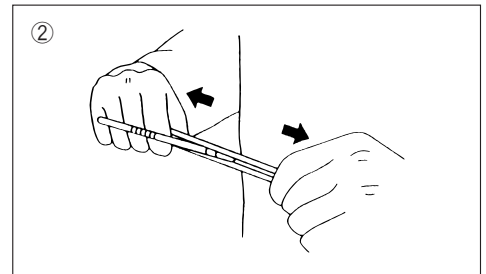

3. Attach the rubber tube holder to the flowmetre outlet. Make certain the tube arrow **G** on the tube pointing in a down direction.

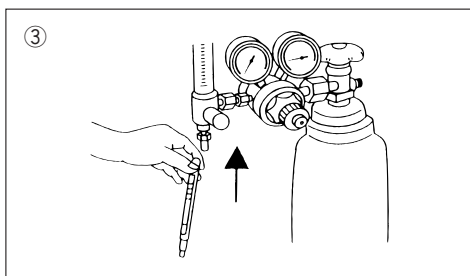

4. Turn on the cylinder or compressor and confirm the flow metre according to each Airtec tube specifications.

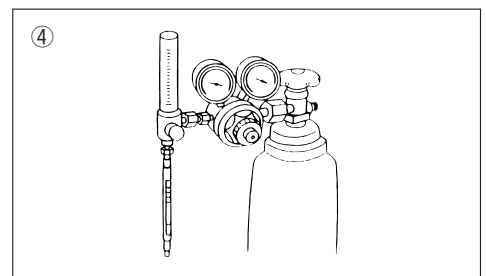

5. Time the sampling time with a stopwatch.

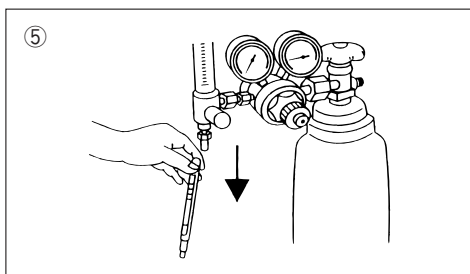

6. As soon as sampling time has elapsed turn off the cylinder or compressor, and remove the tube from the tube holder and then read colour change layer immediately.





## Detector tubes for Automatic Air Sampling Pump

Gas or Vapour to be Measured	Chemical Formula	Tube No. & Name		Measuring Range (ppm)	Flow Rate (mL/min)	Sampling Time (min)	Colour Change		Note	Shelf Life (year)
							Original	Stain		
Acrylonitrile	CH <sub>2</sub> :CHCN	191TP	Acrylonitrile	3.0-12.6 0.2-3.0	50 100	10 10	Yellow	Pink	+T	2
Acetone	CH <sub>3</sub> COCH <sub>3</sub>	151TP	Acetone	25-800	100	10	Yellow	Red	T	2*
Benzene	C <sub>6</sub> H <sub>6</sub>	121P	Benzene	250-3000 μg/m <sup>3</sup>	50	60	White	Brown	+	2
Chlorine	Cl <sub>2</sub>	8TP	Chlorine	0.05-0.6	100	10	Pink	White		2
p-Dichlorobenzene	C <sub>6</sub> H <sub>4</sub> Cl <sub>2</sub>	127P	p-Dichlorobenzene	100-3000 μg/m <sup>3</sup>	100	30	Yellow	Pale reddish purple	+T	2
Ethyl benzene	C <sub>6</sub> H <sub>5</sub> C <sub>2</sub> H <sub>5</sub>	122P	Toluene	110-2750 μg/m <sup>3</sup>	200	30	White	Pale brown	+	2
Ethylene oxide	C <sub>2</sub> H <sub>4</sub> O	163TPM	Ethylene oxide	1-50	50	10	Yellow	Reddish brown	+T	1*
		163TP	Ethylene oxide	0.1-5	50	10	Yellow	Pale orange	+T	1*
Formaldehyde	HCHO	91P	Formaldehyde	0.4-1.44 0.02-0.4	200 200	10 30	Yellow	Pink	T	1*
		91PL	Formaldehyde	0.20-0.80 0.01-0.20	200 200	10 30	Pale Yellow	Pink	T	1*
		91TP	Formaldehyde	0.50-1.75 0.01-0.50	50 100	10 10	Yellow	Pale orange	T	1*
Hexane	CH <sub>3</sub> (CH <sub>2</sub> ) <sub>4</sub> CH <sub>3</sub>	102TP	Hexane	2-80	100	10	Orange	Dark green		3
Hydrogen cyanide	HCN	12TP	Hydrogen cyanide	4.5-9.0 0.3-4.5	50 100	10 10	Yellow	Pink		1
Hydrogen fluoride	HF	17TP	Hydrogen fluoride	3.0-9.0 0.05-3.0	50 100	10 10	Yellow	Brown	TH	2
Hydrogen sulphide	H <sub>2</sub> S	4TP	Hydrogen sulphide	8.0-16.0 0.5-8.0	50 100	10 10	White	Brown		3
Isopropyl alcohol	CH <sub>3</sub> CH(OH)CH <sub>3</sub>	113TP	Isopropyl alcohol	200-400 20-200	100 100	5 10	Pink	Pale blue	T	2
Methanol	CH <sub>3</sub> OH	111TP	Methanol	20-300	50	10	Pink	Pale blue	T	2
Methyl ethyl ketone	CH <sub>3</sub> COC <sub>2</sub> H <sub>5</sub>	152TP	Methyl ethyl ketone	20-300	100	10	Yellow	Red	T	2*
Nitrogen dioxide	NO <sub>2</sub>	9P	Nitrogen dioxide	0.02-0.20	100	30	White	Orange brown	T	2
Tetrachloroethylene	Cl <sub>2</sub> C:CCl <sub>2</sub>	133P	Tetrachloroethylene	300-720 μg/m <sup>3</sup> 20-300 μg/m <sup>3</sup>	100 100	15 30	Yellow	Purple	+T	2
		133TP	Tetrachloroethylene	5-80	100	10	Yellow	Reddish purple	+T	2
Toluene	C <sub>6</sub> H <sub>5</sub> CH <sub>3</sub>	122P	Toluene	2500-7000 μg/m <sup>3</sup> 100-2500 μg/m <sup>3</sup>	200 200	10 30	White	Pale brown	+	2
		122TP	Toluene	2-80	100	10	White	Brown	+	2
Trichloroethylene	Cl <sub>2</sub> C:CHCl	132P	Trichloroethylene	500-1200 μg/m <sup>3</sup> 20-500 μg/m <sup>3</sup>	100 100	15 30	Yellow	Purple	+T	2
		132TP	Trichloroethylene	15-33 1-15	50 100	10 10	Yellow	Reddish purple	+T	2
Vinyl chloride	CH <sub>2</sub> :CHCl	131P	Vinyl chloride	50-1500 μg/m <sup>3</sup>	100	30	Yellow	Pale reddish purple	+T	2
		131TP	Vinyl chloride	3.0-9.6 0.2-3.0	50 100	10 10	Yellow	Reddish purple	T	3
Xylene	C <sub>6</sub> H <sub>4</sub> (CH <sub>3</sub> ) <sub>2</sub>	122P	Toluene	540-13500 μg/m <sup>3</sup>	200	30	White	Pale brown	+	2
		123TP	Xylene	2-80	100	10	White	Brown	+	2

T: Temp Correction H: Humidity Correction +: Twin Tubes \* Refrigerated Storage Mesh: Correction Factor  
See page 36 for additional symbols and definitions.

## Automatic Air Sampling Pump GSP-300FT-2

The Model GSP-300FT-2 has been designed small and compact air sampling pump available with an integrated flowmetre for Hand-held, Personal or site sampling. This small size air sampling pump can be possible to carry on constant flow rate for 10 hours continuous sampling. This air sampling pump employs an extremely low noise air pump and automatic shut-off air pump by preset timer or volume for integrated flow rate and accumulated time.

### GSP-300FT-2 Specification

Spot Flow Rate & Measuring Range	0~250mL/min
Constant Flow Rate Sampling Range	50mL/min : 0.0~34.5kPa 200mL/min : 0.0~21.0kPa 100mL/min : 0.0~30.0kPa 250mL/min : 0.0~16.5kPa 150mL/min : 0.0~25.0kPa*
Operating Mode	Timer mode : Automatic shut-off of air pump by a preset timer and digital display of integral flow rate. Constant volume mode : Automatic shut-off of air pump by a preset timer and digital display of elapsed time.
Indicator	L.C.D. Read-out (equipped Light Switch ) Flow Rate Indicator : mL/min Accumulated Sampling Volume Indicator : 0.000~9.999 L, 10.00~99.99 L, 100.0~999.9 L Maximum Sampling Time Indicator : 0~999 min
Construction & Performance	Mass flow sensor(Temperature Correction Function attached), Diaphragm sampling pump, Dust-proof, Water drop-proof, Auto Start Function, Equipped with initial flow rate maintaining electric circuit
Accuracy of spot and accumulated volume	±5%(at higher than 50mL/minspot flow rate under constant temperature and relative humidity)
Operating temperature and humidity range	Temperature : 0~40°C Humidity : 10~90%RH(without dews)
Power source	2 pcs. Type AA Alkali Dry Cell Battery lasts 10 continuous hours (20°C)
Dimension & weight	80(W)×40(D)×140(H)mm · 300g(with batteries)
Approval	CE-marking (2004/108/EC )

### Measuring Procedure

- Break tips off the detector tube by tube tip holder.



- Insert the detector tube to the inlet of the rubber tube holder.

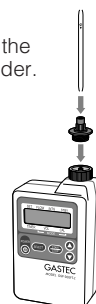

- Put the power switch to ON. Adjust the flow rate, confirm the timer of the air sampling pump is set, then push the start button.
- After sampling, remove the detector tube from the rubber tube holder and read the concentration of the tube.

\* Please read carefully the instruction sheet of the detector tube to be used for timer and flow rate.

**■ GASTEC NUMERICAL INDEX GAS DETECTOR TUBE LIST**

Gastec Tube No.	Gas or Vapour to be Measured	Measuring Range (ppm)
1A	Carbon monoxide (Airtec tube)	5-50
1HH	Carbon monoxide	1-50%
1H		0.1-10%
1M		0.05-4%
1LM		25-2000
1L		2.5-2000
1La		8-1000
1LK		5-600
1LKC		5-100
1LL		5-50
1LC		1-30
1M	Gasoline (Petrol)	0.1-2%
1D	Carbon monoxide (Dosi tube)	1.04-2000
1DL		0.4-400
2A	Carbon dioxide (Airtec tube)	250-3000
2Ag		200-3000
2HT	Carbon dioxide (Injection tube)	10-100%
2HH	Carbon dioxide	2.5-40%
2H		0.5-20%
2L		0.13-6%
2LL		300-5000
2LC		100-4000
2D	Carbon dioxide (Dosi tube)	0.02-12%
3H	Ammonia	0.2-32%
3HM		0.05-3.52%
3M		10-1000
3La		2.5-200
3L	0.5-78	
3H	Dimethylamine	1.2-19.2%
3M	Trimethylamine	25-250
3D	Ammonia (Dosi tube)	2.5-1000
3DL		0.1-10
3D	Dimethylamine (Dosi tube)	1.9-750
3D	Hydrazine (Dosi tube)	1.6-650
3D	N,N-Dimethylethylamine (Dosi tube)	4-1600
3D	Triethylamine (Dosi tube)	5.3-2100
3DL	Methylamine (Dosi tube)	0.19-19
3DL	Trimethylamine (Dosi tube)	0.23-23
4HT	Hydrogen sulphide	1-40%
4HP		0.25-20%
4HH		0.1-4%
4H		10-4000
4HM		25-1600
4M		12.5-500
4L		1-240
4LL		0.25-120
4LK		1-40
4LB		0.5-12
4LT	0.05-4.0	
4TP	Hydrogen sulphide (for Automatic Air Sampling Pump)	0.5-16.0
4D	Hydrogen sulphide (Dosi tube)	0.2-200
5H	Sulphur dioxide	0.05-8%
5M		20-3600
5L		1.25-200
5La		0.5-60
5LC		0.1-25
5Lb		0.05-10
5La		Thionyl chloride
5DH	Sulphur dioxide (Dosi tube)	10-600
5D		0.2-100
6AH	Water vapour (Airtec tube)	500-5000
6A		20-80mg/m <sup>3</sup>
6Ag		150-3000mg/m <sup>3</sup>
6	Water vapour	0.5-32mg/L
6L		0.05-2mg/L
6LP		3-100LB/MMCF
6LLP		2-10LB/MMCF
7H		Phosphine

Gastec Tube No.	Gas or Vapour to be Measured	Measuring Range (ppm)
7J	Phosphine	2.5-1000
7		2.5-100
7L		0.15-5
7LA		0.05-9.8
8HH	Chlorine	0.25-10%
8H		25-1000
8La		0.1-16
8LL		0.025-2
8HH		Hydrogen chloride
8H	Chlorine dioxide	25-250
8La	Bromine	0.05-0.8
8La	Chlorine dioxide	0.3-4.8
8TP	Chlorine (for Automatic Air Sampling Pump)	0.05-0.6
8D	Chlorine (Dosi tube)	0.08-100
9L	Nitrogen dioxide	0.5-125
9L	Iodine	0.2-12
9P	Nitrogen dioxide (for Automatic Air Sampling Pump)	0.02-0.20
9D	Nitrogen dioxide (Dosi tube)	0.1-30
9DL		0.01-3.0
10	NO & NO <sub>2</sub> (Separate quantification)	2.5-200
11A	Nitrogen oxides (Airtec tube)	0.02-2
11HA	Nitrogen oxides (Total quantification)	50-2500
11S		5-625
11L		0.04-16.5
12H	Hydrogen cyanide	0.05-1.6%
12M		17-2400
12L		0.5-150
12LL		0.2-10
12L		Acetone cyanohydrin
12L	Boron trichloride	2.25-54
12TP	Hydrogen cyanide (for Automatic Air Sampling Pump)	0.3-9.0
12D	Hydrogen cyanide (Dosi tube)	1-200
13M	Carbon disulphide	20-4000
13		0.63-100
13L		0.1-8.1
14R	Hydrogen chloride (for Low Humidity)	50-5000
14M	Hydrogen chloride	10-1000
14L		0.2-76
14D	Hydrogen chloride (Dosi tube)	1-100
14D	Hydrogen fluoride (Dosi tube)	2.5-250
14D	Nitric acid (Dosi tube)	0.8-80
15L	Nitric acid	0.1-40
15L	Hydrogen bromide	0.8-16
15L	Trichloroacetic acid	1-37.5
16	Phosgene	0.05-20
17	Hydrogen fluoride	0.25-100
17L		0.09-72
17LL		0.05-24
17	Fluorine	0.5-50
17TP	Hydrogen fluoride (for Automatic Air Sampling Pump)	0.05-9.0
17D	Hydrogen fluoride (Dosi tube)	1-100
17D	Nitric acid (Dosi tube)	0.32-32
18M	Ozone	4-400
18L		0.025-3
19LA	Arsine	0.04-10
21	Carbonyl sulphide	5-200
21LA		2-125
22	Diborane	0.02-5
23M	Chlorine dioxide	0.1-10
23L		0.025-1.2
25	(NH <sub>3</sub> ,SO <sub>2</sub> ,H <sub>2</sub> S,CO,NO <sub>2</sub> , )	Qualitative
26	(NH <sub>3</sub> ,H <sub>2</sub> S,CnHm)	Qualitative
27	(NH <sub>3</sub> ,HCl,H <sub>2</sub> S,NO <sub>2</sub> ,SO <sub>2</sub> ,CO,CO <sub>2</sub> )	Qualitative
28	HCl, COCl <sub>2</sub> , SO <sub>2</sub> , NO <sub>2</sub> , H <sub>2</sub> S, HCN, CO, CO <sub>2</sub>	Qualitative
30	Hydrogen	0.5-2%
31B	Oxygen	3-24%
32	Hydrogen peroxide	0.5-10
32D	Hydrogen peroxide (Dosi tube)	0.5-40

Gastec Tube No.	Gas or Vapour to be Measured	Measuring Range (ppm)
35	Sulphuric acid	0.5-5mg/m <sup>3</sup>
40	Mercury vapour	0.05-13.2mg/m <sup>3</sup>
45H	H <sub>2</sub> S + SO <sub>2</sub> (Total Quantification)	0.02-8.0%
45S	H <sub>2</sub> S,SO <sub>2</sub> (Separate Quantification)	SO <sub>2</sub> : 0.25-20
45S		H <sub>2</sub> S: 1.25-120
51H	1,1,2-Trichloro-1,2,2-trifluoroethane (R113)	250-6000
51H	Chlorodifluoromethane (R22)	0.1-2.4%
51H	Dichlorodifluoromethane (R12)	325-7800
51H	1,2-Dichloro-1,1,2,2-tetrafluoroethane (R114)	475-11400
51H	Halothane	800-6400
51H	1,1,2,2-Tetrachloro-1,2-difluoroethane (R112)	125-3000
51H	Trichlorofluoromethane (R11)	275-6600
51H	1,1,1-Trichloro-2,2,2-trifluoroethane (R113a)	200-4800
51	1,1,2-Trichloro-1,2,2-trifluoroethane (R113)	10-400
51	1,1-Dichloro-1-fluoroethane (R141b)	10-1000
51	2,2-Dichloro-1,1,1-trifluoroethane (R123)	14-1600
51	Dichloropentafluoropropane (R225)	20-800
51	Chlorodifluoromethane (R22)	25-1000
51	Dichlorodifluoromethane (R12)	11-440
51	1,2-Dichloro-1,1,2,2-tetrafluoroethane (R114)	20-800
51	Enflurane	20-1200
51	Halothane	240-960
51	Methyl chloride	12-480
51	1,1,2,2-Tetrachloro-1,2-difluoroethane (R112)	7-280
51	Trichlorofluoromethane (R11)	8-320
51	1,1,1-Trichloro-2,2,2-trifluoroethane (R113a)	10-400
51	2-Chloro-1,1,1,2-tetrafluoroethane (R124)	45-1800
51L	1,1,2-Trichloro-1,2,2-trifluoroethane (R113)	1-54
51L	Chlorodifluoromethane (R22)	2.5-135
51L	Dichlorodifluoromethane (R12)	1.8-97.2
51L	1,1-Dichloro-1-fluoroethane (R141b)	1.1-22
51L	1,2-Dichloro-1,1,2,2-tetrafluoroethane (R114)	1.8-97.2
51L	2,2-Dichloro-1,1,1-trifluoroethane (R123)	1.4-28
51L	Dichloropentafluoropropane (R225)	1.4-28
51L	Enflurane	25-145
51L	Halotane	3-60
51L	Methyl chloride	1.6-86.4
51L	Methylene chloride	1-54
51L	1,1,2,2-Tetrachloro-1,2-difluoroethane (R112)	1-54
51L	Trichlorofluoromethane (R11)	0.8-43.2
51L	1,1,1-Trichloro-2,2,2-trifluoroethane (R113a)	0.8-43.2
52	1-Nitropropane	4.2-252
52	2-Nitropropane	3.7-222
52	Acetonitrile	3-180
52	Nitrogen dioxide	0.5-30
52	Nitroethane	4-240
52	Nitromethane	5-300
53	Dimethyl sulphide	0.25-10
53	Dimethyl disulphide	0.3-6
60	Phenol	0.4-187
60	Napthalene	0.5-14
61	o-Cresol	0.4-62.5
61	m-Cresol	1-25
61	p-Cresol	1-25
70	Mercaptans	0.5-120
70L		0.1-8
70	Ethyl mercaptan	0.5-120
70	Isopropyl mercaptan	10-240
70	Methyl mercaptan	0.35-84
70	Propyl mercaptan	22.5-540
70L	Butyl mercaptan	0.16-12.8
70L	tert-Butyl mercaptan	0.1-8
70L	Ethyl mercaptan	0.1-8
70L	Methyl mercaptan	0.1-8
70L	Propyl mercaptan	0.12-9.6
71H	Methyl mercaptan	20-2700
71		0.25-140
71H	Ethyl mercaptan	100-3800

Gastec Tube No.	Gas or Vapour to be Measured	Measuring Range (ppm)
72	Ethyl mercaptan	0.5-120
72L	Ethyl mercaptan	0.2-75
75	tert-Butyl mercaptan	2.5-150mg/m <sup>3</sup>
75L	tert-Butyl mercaptan	0.5-30mg/m <sup>3</sup>
75L	2-Mercaptoethanol	0.5-7.5
76H	Tetrahydrothiophene	10-200
76M		10-100mg/m <sup>3</sup>
76		1-10
77	TBM,DMS	1-15mg/m <sup>3</sup>
80	Acid gases	1-80
80	Chlorine	0.7-14
80	Hydrogen chloride	8-160
80	Iodine	0.12-2.4
80	Nitric acid	5-100
80	Nitrogen dioxide	0.2-4
80	Sulphur dioxide	1.5-30
81	Acetic acid	1-100
81L		0.125-25.0
81	Acetic anhydride	0.6-15
81	Acrylic acid	2-50
81	Formic acid	5.2-130
81	Isovaleric acid	2-50
81	Maleic anhydride	0.8-20
81	Methacrylic acid	1.8-45
81	Propionic acid	3-75
81L	Acetic anhydride	0.15-6
81L	Acrylic acid	0.45-18
81L	Butyric acid	0.325-13
81L	Formic acid	0.5-20
81L	Isovaleric acid	0.38-15
81L	Methacrylic acid	0.35-14
81L	Propionic acid	0.25-10
81L	Valeric acid	0.38-15
81D	Acetic acid (Dosi tube)	0.5-100
81D	Acetic anhydride (Dosi tube)	0.3-60
81D	Formic acid (Dosi tube)	0.55-110
91M	Formaldehyde	8-6400
91		2-100
91L		0.1-40
91LL		0.05-1
91L	Benzaldehyde	4-92
91L	Cyclohexanone	10-470
91L	Diisobutyl ketone	0.58-29
91L	Methaldehyde	0.065-3.25
91L	Propionaldehyde	0.76-38
91P	Formaldehyde (for Automatic Air Sampling Pump)	0.02-1.44
91PL		0.01-0.80
91TP		0.01-1.75
91D	Formaldehyde (Dosi tube)	0.1-20
91D	Acetaldehyde (Dosi tube)	0.1-20
91D	Furfural (Dosi tube)	0.3-60
91D	Methyl ethyl ketone (Dosi tube)	0.125-25
92	Acetaldehyde	5-750
92M		2.5-100
92L		1-20
92	Diacetyl	25-1500
93	Acrolein	3.3-800
100A	LPG (Liquified petroleum gas)	0.02-0.8%
100A	Olefines	0.34-13.6%
100A	Propylene	0.02-0.8%
100A	Xylene	0.1-1.2%
100B	Propane (Injection tube)	0.1-2%
101	Gasoline (Petrol)	0.015-1.2%
101L		30-2000
101	Heptane	0.015-1.2%
101	Isooctane	0.027-0.54%
101	Octane	0.036-0.72%
101L	Allyl chloride	0.1-3.4%

Gastec Tube No.	Gas or Vapour to be Measured	Measuring Range (ppm)
101L	Heptane	30-2000
101L	Isobutene	0.07-2.2%
102H	Hexane	0.015-1.2%
102L	Hexane	4-1200
102H	Cyclohexane	0.015-1.2%
102H	Methylcyclohexane	0.04-0.84%
102L	Acrylonitrile	600-14400
102L	Chlorocyclohexane	50-1200
102L	Cyclohexane	60-1440
102L	Diisobutyl ketone	0.2-1%
102L	tert-Butyl alcohol	500-12000
102TP	Hexane (for Automatic Air Sampling Pump)	2-80
103	Hydrocarbons (Lower class)	0.05-2.4%
103	Acetylene	0.075-3.6%
103	Butane	0.035-1.68%
103	Ethylene	0.35-16.8%
103	Heptane	0.035-1.68%
103	Isobutane	0.035-1.68%
103	Isopentane	0.045-2.16%
103	Hexane	0.025-1.2%
103	Pentane	0.0375-1.8%
103	Propane	0.05-2.4%
104	Butane	25-1400
104	Isobutane	55-3080
104	Pentane	30-1680
105	Hydrocarbons (Higher class)	100-3000
105	Heptane	90-2700
105	Hexane	80-2400
105	Nonane	130-3900
105	Octane	100-3000
105	Decane	200-6000
106	Petroleum naphtha	0.5-28mg/L
106	Petroleum benzine	0.5-28mg/L
106	Petroleum ether	0.5-28mg/L
107	Unknown Gases	Qualitative
108	Kerosene, Gasoline	Qualitative
109AD	Oil mist (Airtec tube)	0.2-5mg/m <sup>3</sup>
109A		0.3-1.5mg/m <sup>3</sup>
111	Methanol	0.002-4.5%
111L		20-1000
111LL		2-56
111L	Ethylene chlorohydrin	80-200
111TP	Methanol (for Automatic Air Sampling Pump)	20-300
112	Ethanol	0.01-7.5%
112L		50-2000
112D	Ethanol (Dosi tube)	100-25000
113	Isopropyl alcohol	0.02-5.0%
113L		20-800
113LL		20-460
113	Propyl alcohol	0.04-2.5%
113L	Divinyl methoxysilane	6.5-25.0
113L	Ethylene glycol monobutyl ether	200-1000
113L	Ethylene glycol monoethyl ether	110-1000
113L	Ethylene glycol monomethyl ether	75-760
113L	Ethylene glycol monomethyl ether acetate	300-1300
113L	Propyl alcohol	130-560
113L	Vinyl trimethoxysilane	6.5-25.0
113LL	Ethylene glycol monobutyl ether	60-400
113LL	Ethylene glycol monoethyl ether	46-460
113LL	Ethylene glycol monomethyl ether	44-440
113LL	1-Methoxy-2-propanol	26-260
113LL	Propyl alcohol	55-170
113TP	Isopropyl alcohol (for Automatic Air Sampling Pump)	20-400
114	1-Butanol	10-150
115	2-Butanol	5-150
116	Isobutyl alcohol	10-150
117	Isoamyl alcohol	5-300
118	Cyclohexanol	5-100

Gastec Tube No.	Gas or Vapour to be Measured	Measuring Range (ppm)
119	Methylcyclohexanol	5-100
120	Aromatic hydrocarbons	0.4-200
121S	Benzene	2-312
121		2.5-120
121SL		1-100
121L		0.1-65
121SP		0.2-66
121	Diisobutylene	45-540
121	α-Pinene	95-1140
121L	Methylene iodide	0.22-22
121L	Methyl iodide	0.32-32
121P	Benzene (for Automatic Air Sampling Pump)	250-3000μg/m <sup>3</sup>
122	Toluene	5-690
122L		1-100
122	Ethyl benzene	11-330
122L	Cumene	2-100
122L	Diethyl benzene	2-150
122L	Ethyl benzene	1-70
122L	Xylene	2-200
122P	Toluene (for Automatic Air Sampling Pump)	100-7000μg/m <sup>3</sup>
122TP		2-80
122P	Ethyl benzene (for Automatic Air Sampling Pump)	110-2750μg/m <sup>3</sup>
122P	Xylene (for Automatic Air Sampling Pump)	540-13500μg/m <sup>3</sup>
122DL	Toluene (Dosi tube)	2-500
122DL	Benzene (Dosi tube)	2.4-600
122DL	Cumene (Dosi tube)	3.4-850
122DL	Ethyl benzene (Dosi tube)	2.8-700
122DL	Xylene (Dosi tube)	3.4-850
122DL	Styrene (Dosi tube)	26-6500
123	Xylene	5-625
123L		2-200
123	Trimethyl benzene	10-300
123TP	Xylene (for Automatic Air Sampling Pump)	2-80
124	Styrene	10-1500
124L		2-100
124L	Divinyl benzene	1-15
126	Chlorobenzene	2-500
126L		0.5-43
127	o-Dichlorobenzene	2.5-300
127	m-Dichlorobenzene	2.5-300
127	p-Dichlorobenzene	2.5-300
127P	p-Dichlorobenzene (for Automatic Air Sampling Pump)	100-3000μg/m <sup>3</sup>
128	Stoddard solvent	50-8000mg/m <sup>3</sup>
130L	Vinylidene chloride	0.4-40.6
131	Vinyl chloride	0.025-2%
131La		0.25-54
131L		0.1-6.6
131LB		0.25-70
131L	1,1,2,2-Tetrachloroethane	2-30
131L	Allyl chloride	3.2-48
131La	1,3-Dichloropropene	0.5-10
131La	1,2,4-Trichlorobenzene	0.65-13
131La	2-Methyl allyl chloride	2.8-55
131La	Ethyl chloroformate	7-140
131La	Methyl chloroformate	58-1160
131La	p-Ethyl benzylchloride	2.5-50
131La	Propylene dichloride	40-800
131P	Vinyl chloride (for Automatic Air Sampling Pump)	50-1500μg/m <sup>3</sup>
131TP		0.2-9.6
132HH	Trichloroethylene	0.05-2.5%
132HA		20-1300
132M		2-250
132L		1-70
132LL		0.125-8.8
132HH	Tetrachloroethylene	0.075-1.5%
132HA	1,2-Dichloroethylene	80-800
132HA	1,3-Dichloropropene	45-450
132L	Benzyl chloride	1.6-20

Gastec Tube No.	Gas or Vapour to be Measured	Measuring Range (ppm)
132LL	1,2-Dichloroethylene	0.375-6
132LL	Dichlorvos	0.11-1.8
132P	Trichloroethylene (for Automatic Air Sampling Pump)	20-1200µg/m <sup>3</sup>
132TP		1-33
132D	Trichloroethylene (Dosi tube)	3-300
132D	Chlorine (Dosi tube)	2.4-240
132D	1,2-Dichloroethylene (Dosi tube)	6-600
132D	Hydrogen chloride (Dosi tube)	1.8-180
132D	Tetrachloroethylene (Dosi tube)	1.5-150
133HA	Tetrachloroethylene	7-900
133M		2-250
133L		1-75
133LL		0.1-9
133L	Pentachloroethane	40-500
133P	Tetrachloroethylene (for Automatic Air Sampling Pump)	20-720µg/m <sup>3</sup>
133TP		5-80
133D	Tetrachloroethylene (Dosi tube)	3-150
134	Carbon tetrachloride	0.5-60
134L		0.25-12
134	Chloropicrin	2.5-60
134L	Chloropicrin	0.125-2.5
135	1,1,1-Trichloroethane(Methyl chloroform)	100-2000
135L		6-900
135	1,1,2-Trichloroethane	220-750
135	1,1-Dichloroethane	90-450
135	Chlorobromomethane	22-110
135	Ethylene dichloride	400-2000
135L	1,1,2,2-Tetrabromoethane	0.92-9.2
135L	1,2,3-Trichloropropane	36-360
135L	Ethylene dichloride	104-1040
136H	Methyl bromide	10-600
136L		2.5-200
136LA		1-36
136LL		0.1-3.0
136H	n-Butyl bromide	24-360
136H	Chloro bromomethane	18-270
136H	Ethylene dibromide	14-210
136L	1,1-Dibromoethane	7-70
136L	Benzyl bromide	10-100
136L	Bromoform	1-50
136L	n-Butyl bromide	10-100
136L	Chlorobromomethane	11-110
136L	Dibromomethane	5-50
136L	Ethyl bromide	2.5-200
136L	Ethylene dibromide	8-80
136LA	n-Butyl bromide	1-43.2
136LA	n-Propyl bromide	1-18
136LA	Chloro bromomethane	0.7-12.6
137	Chloroform	4-400
137LA		0.5-30
137LL		0.3-4.5
138	Methylene chloride	20-500
138L		4-150
138	Ethyl chloride	15-150
139	1,2-Dichloroethylene	5-250
140	Aliphatic hydrocarbons	6-3000
141	Ethyl acetate	0.1-1.5%
141L		20-800
141	Vinyl acetate	0.06-0.9%
141L	2-Hexyl alcohol	60-2400
141L	Cymene	5.6-224
141L	Diisopropyl benzene	10-400
141L	Ethyl acrylate	8-320
141L	Isopropyl ether	18-720
141L	Mesityl oxide	27-1080
141L	Methyl acrylate	8-320
141L	Methyl isothiocyanate	50-400
142	Butyl acetate	0.05-0.8%

Gastec Tube No.	Gas or Vapour to be Measured	Measuring Range (ppm)
142L	Butyl acetate	10-300
142L	Butyl acrylate	7-210
142L	Isobutyl acrylate	2.6-78
143	Vinyl acetate	5-250
144	Isobutyl acetate	10-300
145	Propyl acetate	20-500
146	Isopropyl acetate	10-500
147	n-Amyl acetate	10-200
148	Isoamyl acetate	10-200
149	Methyl methacrylate	10-500
149	Allyl Isothiocyanate	5-200
151	Acetone	0.05-2.0%
151L		50-12000
151	Cyclohexene	0.05-0.8%
151L	Methyl ethyl ketone	21-1680
151L	Propionaldehyde	24-1880
151TP	Acetone (for Automatic Air Sampling Pump)	25-800
151D	Acetone (Dosi tube)	5-1500
151D	Acetaldehyde (Dosi tube)	4-1200
151D	Methyl ethyl ketone (Dosi tube)	6.5-1950
151D	Methyl isobutyl ketone (Dosi tube)	11.5-3450
152	Methyl ethyl ketone	0.02-0.6%
152L		10-384
152TP	Methyl ethyl ketone (for Automatic Air Sampling Pump)	20-300
152D	Methyl ethyl ketone (Dosi tube)	2-600
152D	Acetaldehyde (Dosi tube)	1.2-360
152D	Acetone (Dosi tube)	1.4-420
152D	Methyl isobutyl ketone (Dosi tube)	4-1200
153	Methyl isobutyl ketone	0.05-0.6%
153L		2.5-130
153	Styrene	0.075-0.9%
154	Cyclohexanone	2-75
154	Diacetone alcohol	2.5-100
154	Furfural	2-30
154	Isophorone	2-30
155	Methylcyclohexanone	2-100
159	Tetrahydrofuran	20-800
159L		5-232
159	1,4-Dioxane	25-140
161	Ethyl ether	0.04-1.0%
161L		10-1200
161	Isopropyl ether	0.018-0.45%
161	Methyl ether	0.03-0.85%
161	Tetrahydrofuran	0.056-1.4%
161	Toluene	0.02-0.8%
163	Ethylene oxide	0.05-3.0%
163L		0.4-350
163LL		0.1-10
163	1,4-Dioxane	0.1-6.0%
163	Propylene oxide	0.065-3.9%
163L	Epichlorohydrin	1.2-120
163L	Propylene oxide	1-100
163TPM	Ethylene oxide (for Automatic Air Sampling Pump)	1-50
163TP		0.1-5
165L	Ethylene glycol	10-100mg/m <sup>3</sup>
171	Acetylene	0.05-4.0%
171	Benzene	0.03-0.6%
171	Ethylene	0.1-2.0%
171	1,1,1-Trichloroethane	0.06-1.2%
172	Ethylene	25-1680
172L		0.2-100
172	Acetylene	32.5-1040
174	1,3-Butadiene	50-800
174L		2.5-100
174LL		0.5-5
174	1,3-Pentadiene	250-4000
174L	1,3-Pentadiene	42.5-850
174D	1,3-Butadiene (Dosi tube)	1.3-200

Gastec Tube No.	Gas or Vapour to be Measured	Measuring Range (ppm)
174D	Ethylene (Dosi tube)	1.5-240
174D	Isoprene (Dosi tube)	2.5-400
174D	trans-1,2-Dichloroethylene (Dosi tube)	3.8-600
174D	Vinyl chloride (Dosi tube)	1.5-240
180	Amines	5-100
180L		0.5-10
180	Allyl amine	8.5-170
180	Ammonia	1.5-30
180	Butylamine	8-160
180	tert-Butylamine	5.5-110
180	Di-n-Butylamine	5-100
180	Cyclohexylamine	7-140
180	Diethylamine	5.5-110
180	Diethylethanolamine	6-120
180	Diisopropylamine	5-100
180	Dimethyl ethanolamine	6.5-130
180	Dimethylamine	5.5-110
180	Dimethylaminopropylamine	8-160
180	Dipropylamine	4-80
180	N,N-Dimethylethylamine	4-80
180	N-Ethyl morpholine	5-100
180	Ethylamine	5-100
180	Ethylenediamine	14-280
180	Hexylamine	9-180
180	Isopropyl amine	5.5-110
180	Methylamine	5-100
180	N-Methyl morpholine	5-100
180	N-Methyl pyrrolidone	13.5-270
180	Monoethanolamine	7-140
180	Morpholine	9-180
180	Propylamine	6-120
180	Propylene imine	5.5-110
180	Tetramethylenediamine	8.5-170
180	Triethylamine	4.5-90
180	Trimethylamine	3.5-70
180L	Allyl amine	0.4-8
180L	Butylamine	0.55-11
180L	Cyclohexylamine	0.5-10
180L	Di-n-butylamine	0.4-8
180L	Diethylamine	0.45-9
180L	Diethylaminoethanol	0.6-12
180L	Diethylenetriamine	0.95-19
180L	Diisopropylamine	0.3-6
180L	Dimethylamine	0.45-9
180L	2-Dimethylaminoethanol	0.65-13
180L	Dimethylaminopropylamine	0.6-12
180L	N,N-Dimethylethylamine	0.3-6
180L	Dipropylamine	0.35-7
180L	Ethanolamine	1.95-39
180L	Ethylamine	0.45-9
180L	Ethylenediamine	0.9-18
180L	N-Ethyl morpholine	0.3-6
180L	Hexamethylenediamine	1.55-31
180L	Hexylamine	0.65-13
180L	Isopropylamine	0.45-9
180L	Methylamine	0.5-10
180L	Morpholine	0.5-10
180L	N-Methyl morpholine	0.3-6
180L	Pentamethylenediamine	0.75-15
180L	Propylamine	0.5-10
180L	Propylene imine	0.35-7
180L	Tetramethylenediamine	0.8-16
180L	Triethylamine	0.3-6
180L	Trimethylamine	0.25-5
181	Aniline	1.25-60
181	N,N-Dimethylaniline	2.5-30
181	N-Methyl aniline	3.5-42
181	o-Toluidine	5-60

Gastec Tube No.	Gas or Vapour to be Measured	Measuring Range (ppm)
182	Pyridine	0.2-35
182	4-Methyl pyridine	0.38-10.5
183	N,N-Dimethyl formamide	0.8-90
184	N,N-Dimethyl acetamide	1.5-240
185	Hydrazine	0.05-2
185	Dimethylhydrazine	0.1-2
185	Methyl hydrazine	0.6-12
191	Acrylonitrile	2-360
191L		0.1-18
191	Propionitrile	50-1200
191L	2-Methyl-3-butenitrile	0.4-12
191L	2-Pentenitrile	0.24-7.2
191L	3-Pentenitrile	0.4-12
191L	Butyronitrile	6-180
191TP	Acrylonitrile(for Automatic Air Sampling Pump)	0.2-12.6
192	Methacrylonitrile	0.2-32
193	2-Pentenitrile	0.5-15
211H	Sulphide ion in solution	10-1000
211M		2-300
211		1-100
211LL		0.5-20
218	Ozone in solution	1-10mg/L
221L	Chloride ion in solution	25-1000mg/L
221LL		10-200mg/L
221L	Bromide ion in solution	55-2200mg/L
221LL	Bromide ion in solution	24-480mg/L
222	Free residual chlorine	0.1-10mg/L
230H	Methyl iodide	100-34800
230		0.5-108
231	Sulphuryl fluoride	1-20
232	1,2-Dichloroethane	1-39
233	Chloropicrin	0.045-22
271	Mercury in solution	1-20mg/L
273	Chromium(VI) ion in solution	0.5-50mg/L
281	Iron ion in solution	5-50mg/L
284	Copper ion in solution	1-20mg/L
285	Zinc in solution	3-20mg/L
291	Nickel in solution	5-50mg/L

### ■ About operating environment

Most tubes can be used in the temperature range of 0 -40°C and relative humidity range of 0 -90%. However a few tubes have different temperature range or humidity range. Please refer instruction manuals when use.

### ■ Storage and disposal of Gastec detector tubes

As detector tubes contain sensitive reagents that are ready to react, and some reagents might be corrosive, care should be taken for their storage and disposal.

#### ● Storage of detector tubes

To keep the high quality of Gastec detector tubes, it is necessary to store them in a cool (0 to 10°C (32 to 50° F), dark place (never expose them to the direct sunlight).

Never store tubes above normal room temperature. Keep them in a safe place and out of reach of children.

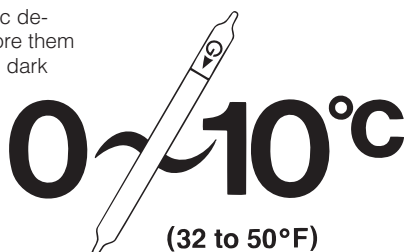

#### ● Disposal of detector tubes

Used or date-expired detector tubes should be disposed properly in accordance with your local regulations. For further information, consult your Gastec representative.

### ■ Units of concentrations

% (Per cent)

Ratio of the volume of a substance to the volume of its medium expressed in percentage:

$$= \frac{\text{Volume of substance}}{\text{Volume of medium}} \times 100$$

ppm (parts per million)

Ratio of the volume of a substance to the volume of its medium expressed in parts per million:

$$= \frac{\text{Volume of substance}}{\text{Volume of medium}} \times 10^6$$

ppb (parts per billion)

Ratio of the volume of a substance to the volume of its medium expressed in parts per billion:

$$= \frac{\text{Volume of substance}}{\text{Volume of medium}} \times 10^9$$

mg/m<sup>3</sup> (milligrams per cubic metre)

Ratio of the weight of a substance expressed in mg to the volume of its medium of 1 m<sup>3</sup> (1,000L). This unit is mainly used for concentrations of particulate substances, but can also be applied to gases and vapours.

mg/L (milligrams per litre)

Ratio of the weight of a substance expressed in mg to the volume of its medium of 1L. This unit is mainly used for concentrations of particulate substances, but can also be applied to gases and vapours.

LB/MMCF (pounds per million cubic feet)

Ratio of the weight of a substance expressed in LB to the volume of its medium of 1,000,000 cubic feet.

$$1\text{mg/L} = 1000\text{mg/m}^3 = 1358\text{ppm} = 62.3\text{LB/MMCF} (25^\circ\text{C}, 1013\text{hPa})$$

#### ● Relations between concentration units

$$\text{ppm} = \% \times 10,000$$

$$\% = \text{ppm} \times 0.0001$$

$$\text{ppb} = \% \times 10,000,000$$

$$\% = \text{ppb} \times 0.0000001$$

$$\text{mg/m}^3 = \text{ppm} \times \frac{M}{22.4} \times \frac{273}{(273+t)} \times \frac{P}{1013}$$

$$\text{ppm} = \text{mg/m}^3 \times \frac{22.4}{M} \times \frac{(273+t)}{273} \times \frac{1013}{P}$$

$$\% = \text{mg/L} \times \frac{22.4}{M} \times \frac{(273+t)}{273} \times \frac{1}{10}$$

$$\text{mg/L} = \% \times \frac{M}{22.4} \times \frac{273}{(273+t)} \times 10$$

Where :

M: Molecular weight

22.4 (L) : Volume of 1 mol at 0°C (32°F) under 1 atmospheric pressure

273 (°K) : °K represents an absolute temperature.  
0°C ≙ 273°K, t°C=(273 + t)°K

1013 (hPa) : 1 atmospheric pressure in hectopascal

P : Atmospheric pressure at the time of measurement in hectopascal

**Quantity of tubes per box:** 10 tubes each

#### Tube No. & Name:

Gastec Detector Tube to be used.

#### Measuring Range:

Measuring ranges can be obtained by multiple or half pump strokes taken.

#### TLV:

Threshold Limit Value (TLV) for 2014 adopted by American Conference of Governmental Industrial Hygienists (ACGIH).

#### TLV-TWA:

Threshold Limit Value-Time Weighted Average -the time-weighted average concentration for a normal 8-hour workday and a 40-hour workweek, to which nearly all workers may be repeatedly exposed, day after day, without adverse effect.

#### TLV-C:

The concentration that should not be exceeded during any part of the working exposure.

#### Note:

T Tubes need a temperature correction factor or table for the true concentration.

H Tubes need a humidity correction factor or table for the true concentration.

+ Five tests (tubes) per box. Twin tubes to be combined with primary and analyzer tubes.

++ Nine tests (tubes) per box.

M Tube 121SP Benzene tube in the mixture of other Hydrocarbons.

⊕ Five tests (tubes) and long size glass detector tube for tube 31B only.

#### Shelf Life (year):

Actual shelf life (the term of validity) is printed on the tube box in final inspection process.

#### Refrigerated Storage:

\* Tubes to be stored at 10°C (50°F) or below.

#### No. of Pump Strokes:

Number in circle means standard pump strokes.

One ① stroke of the sampling pump draws a 100ml air sample. One half ② pump strokes draw a 50ml air sample.

#### Correction factor/chart:

Mesh means a correction factor or chart for the true concentration which is enclosed with each box of detector tubes.

Detector tubes are primarily designed to measure specific gases. But it is also possible to measure other substances of similar chemical properties with the aid of a correction factor or chart. A correction factor is a figure which is multiplied by the concentration interpreted from the colour starting on the detector tube. The correction may also be presented as a chart on tube if the correction relationship is nonlinear. Therefore, please make use of the correction factor/chart measuring ranges as a reference. Moreover, this factor may vary slightly between production batches. For a more precise factor please contact your Gastec distributor.

#### Tube 72P

Tube No.72P works directly off regulated residential LP gas line pressure.

#### Warning

1. Use only Gastec detector tubes with a Gastec Pump.
2. Do not interchange or use non-Gastec parts or components in Gastec's detector tube and pump system.
3. The use of non-Gastec parts or components in Gastec's detector tube and pump system or use of a non-Gastec detector tube with a Gastec pump or use of a Gastec detector tube with a non-Gastec pump may result in property damage, serious bodily injury, and death; voids all warranties; and voids all performance and data accuracy guaranties.

For all types of gas and vapour SINCE 1970



**GASTEC CORPORATION**

8-8-6 Fukayanaka, Ayase-City, Kanagawa 252-1195, Japan

Tel: +81(0)467-79-3910 Fax: +81(0)467-79-3979

URL: <http://www.gastec.co.jp/>

As a result of Gastec's commitment to continual improvement,  
specifications are subject to change without notice.

CA00DTE19 15D4D